

Mini Moog Oscillator Board #1 Component Layout Rev1

CAE Sound
Trim Pot Location

Range

Scale

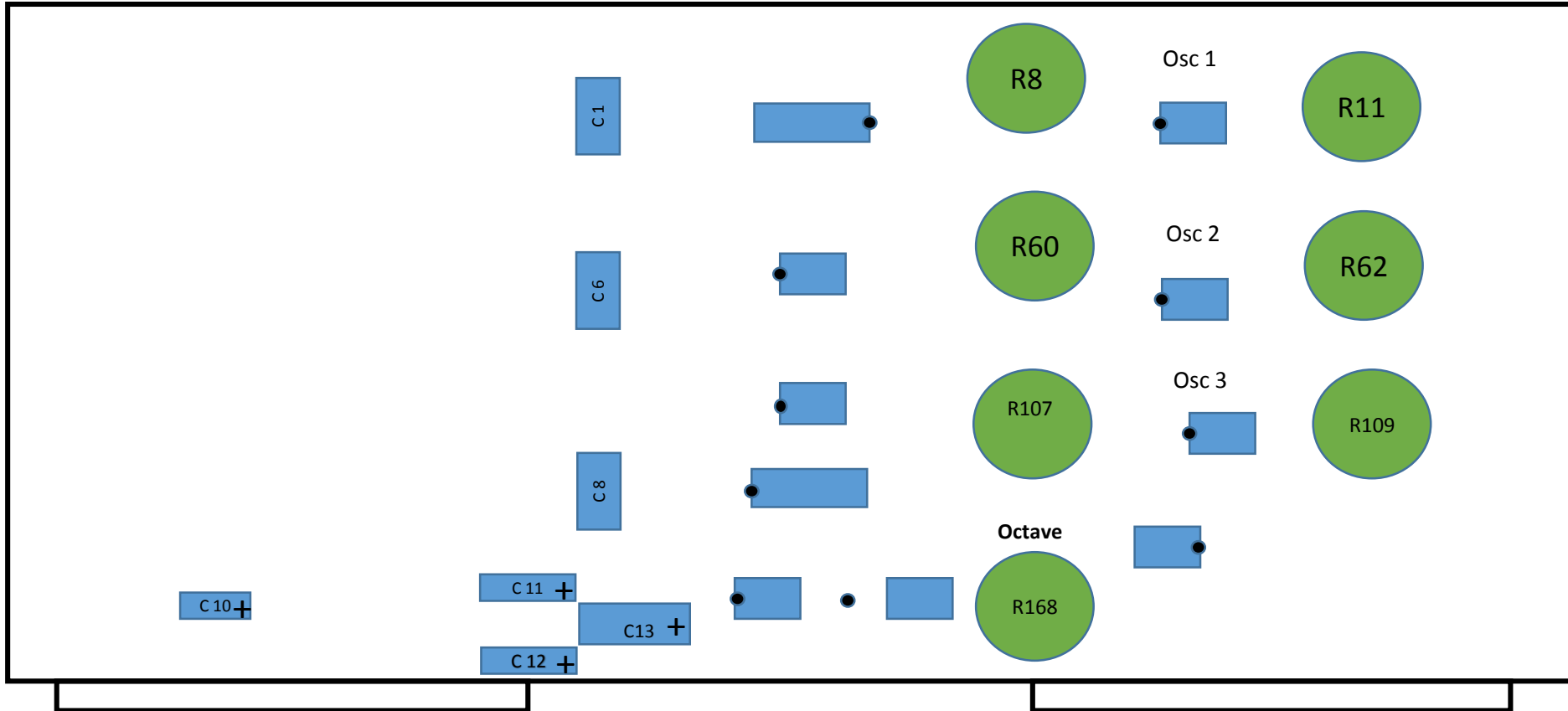

CAE Sound
www.caesound.com
www.caesound.net
 650 348 2737

Parts List Rev 1.0

Trim Pot Replacement

R8	100 Ohms	C 10	2.2uF 25V
R11	1K Ohms	C 11	6.8uF 15V
R60	100 Ohms	C 12	6.8uF 15V
R62	1K Ohms	C 13	22uF 25V
R107	100 Ohms		
R109	1k Ohms		
R168	50 Ohms		

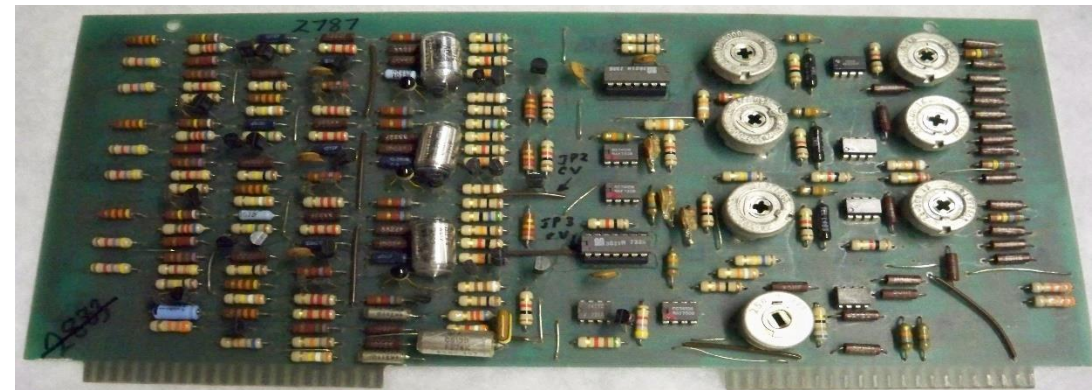

Mini Moog VCF – VCA Board #4
Trim Pot Location

CAE Sound
www.caesound.com
www.caesound.net
650 348 2737

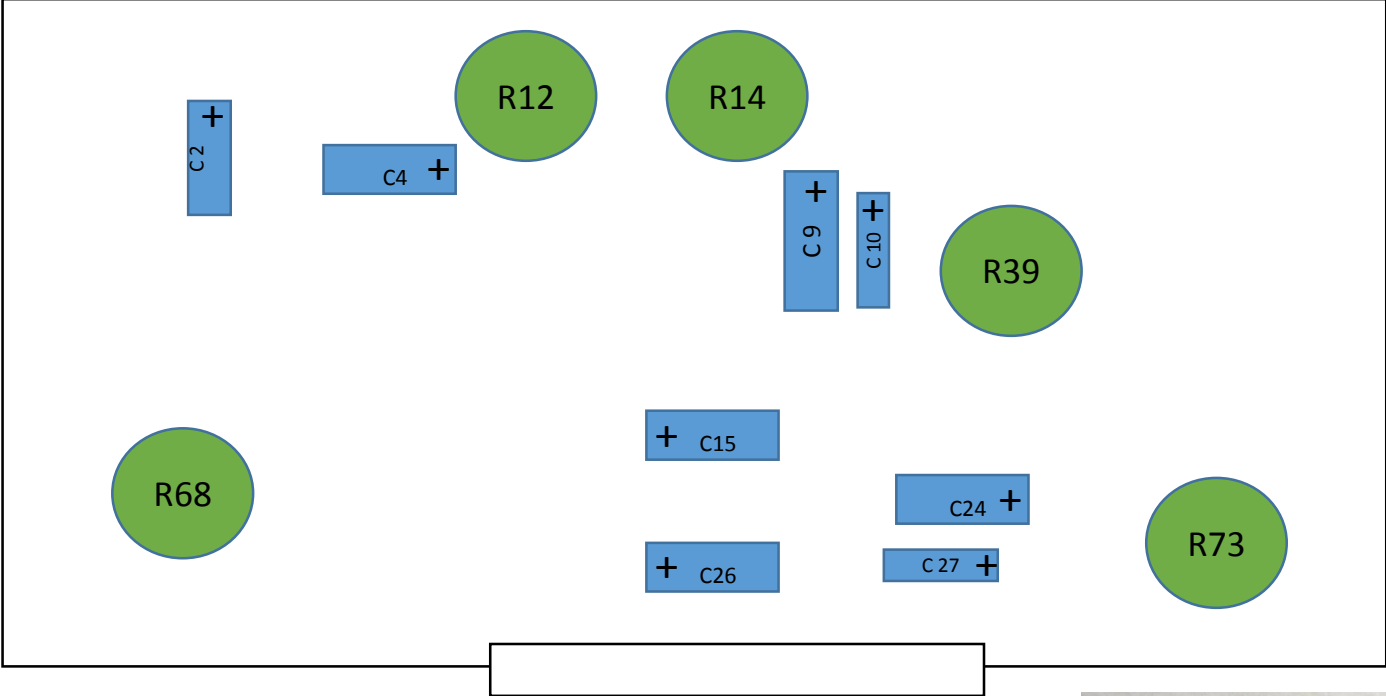

Parts List	Rev 1.0		
Trim Pot Replacement		C 2	10uF 50V
R12	100 Ohms	C 4	220uf 6.3V
R14	100 Ohms	C 9	100uF 35V
R39	10K Ohms	C 10	10uF 50V
R68	1K Ohms	C 15	220uF 6.3V
R73	1K Ohms	C 24	220uF 6.3V
		C 26	220uF 6.3V
		C 27	10uF 50V

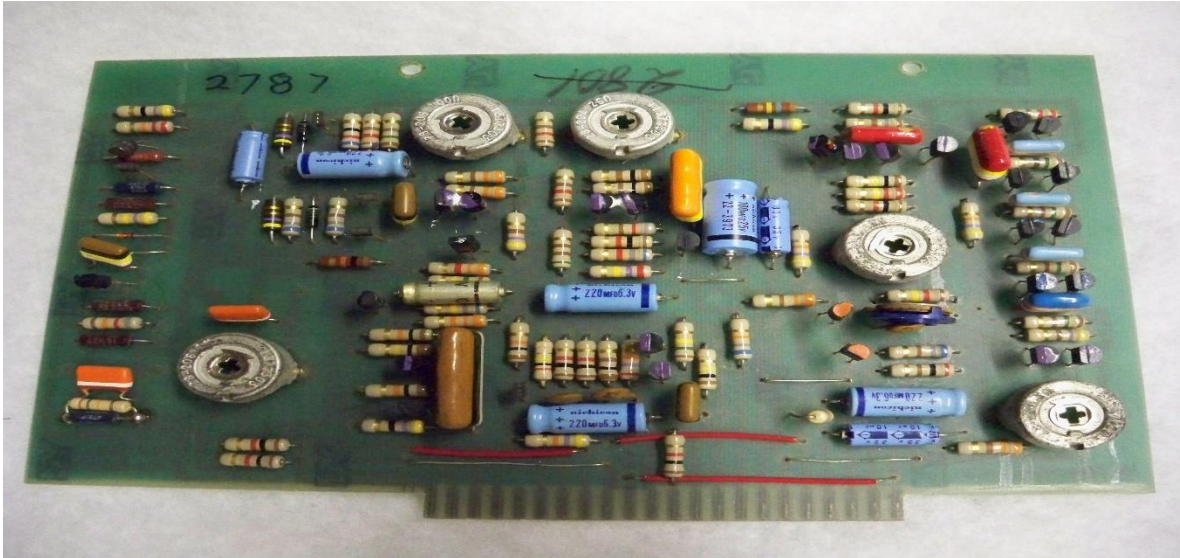

Mini Moog VCF – VCA Board #4
Trim Pot Location

CAE Sound
www.caesound.com
www.caesound.net
 650 348 2737

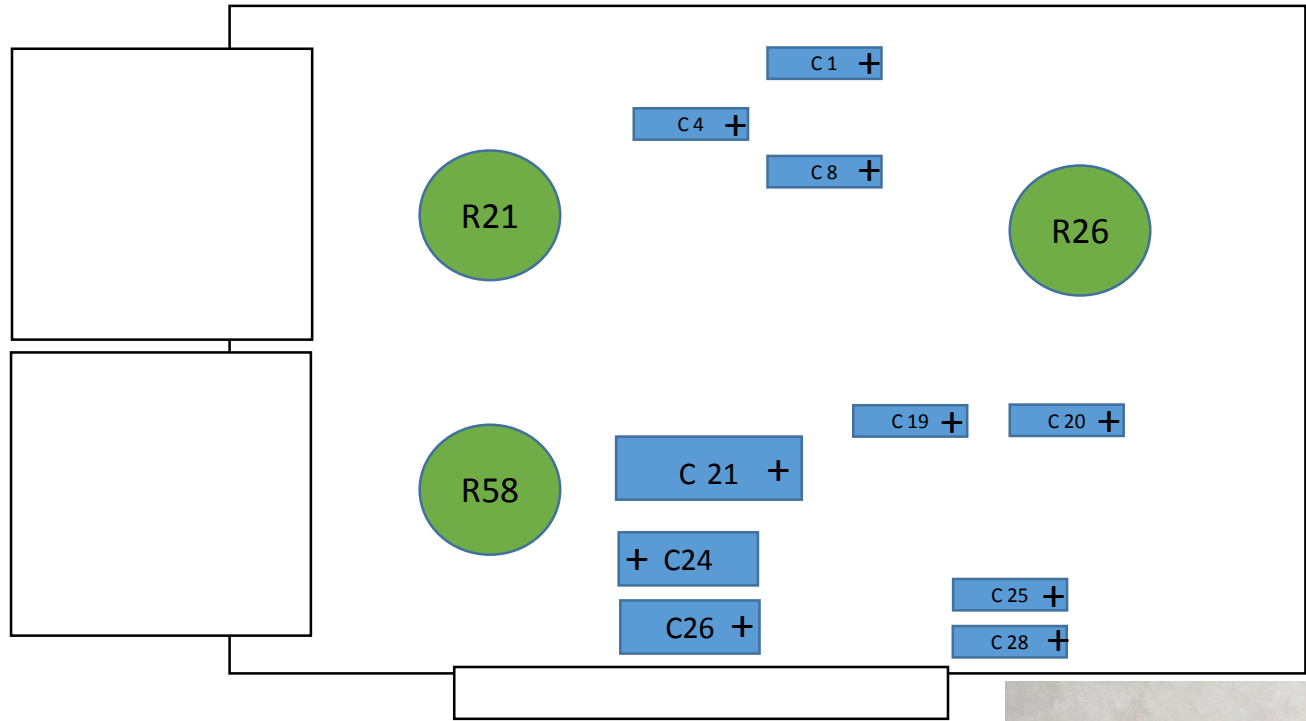

Parts List	Rev 1.0	C 1	2.2uF 50V
Trim Pot Replacement		C 4	2.2uF 50V
R21	25 Ohms	C 8	2.2uF 50V
R58	10 Ohms	C 19	2.2uF 50V
R26	2.5K Ohms	C 20	2.2uF 50V
		C 21	470uF 16V
		C 24	100uF 35V
		C 26	100uF 25V
		C 25	10uF 35V
		C 28	10uF 35V

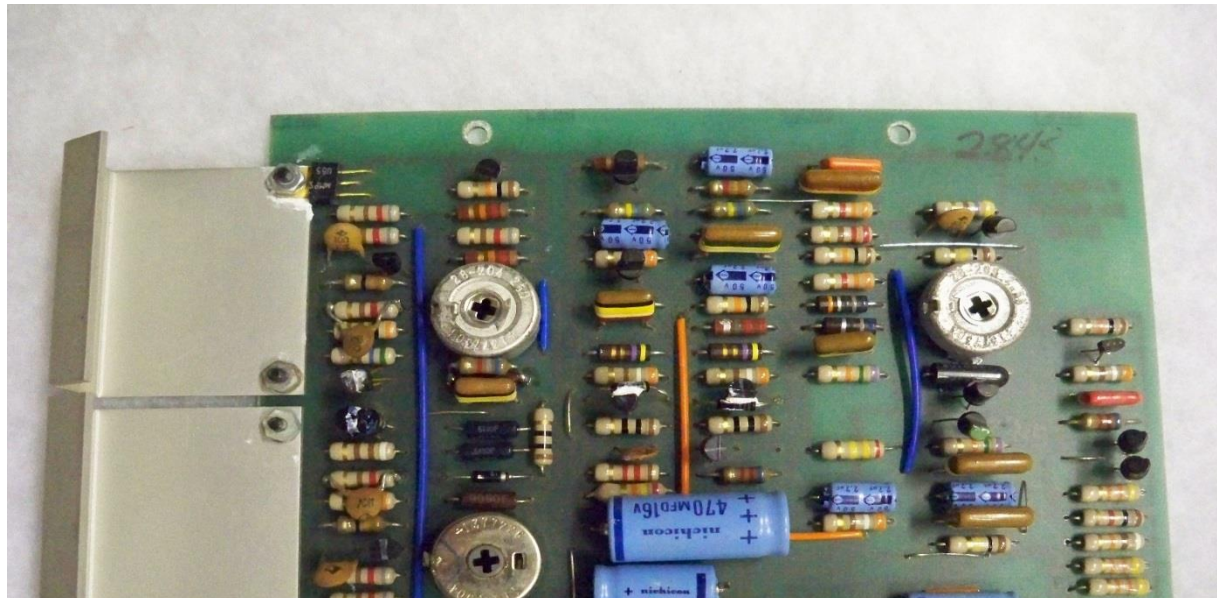

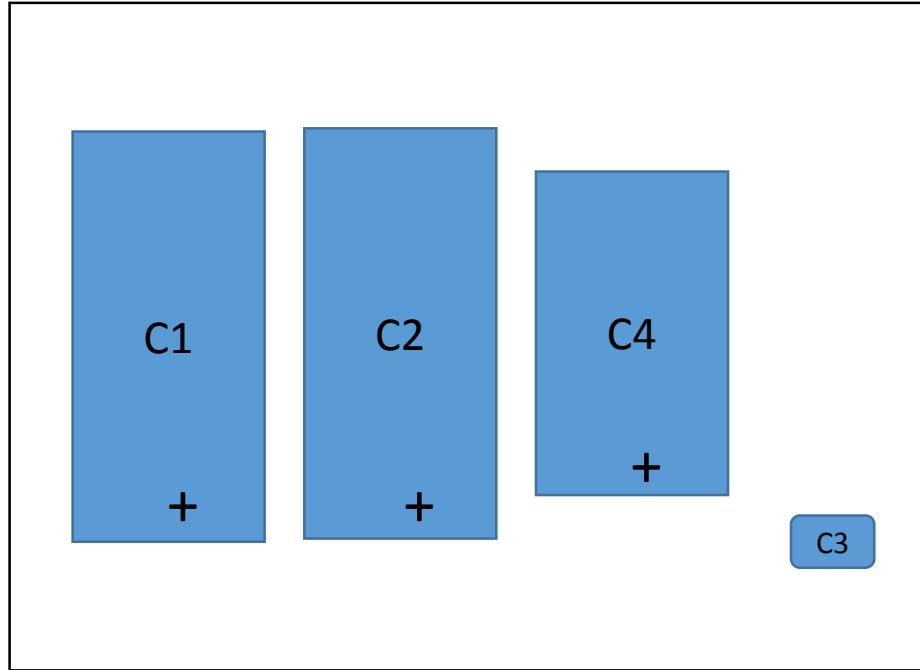

Parts List Rev 1.0
Trim Pot Replacement

<u>C 1</u>	<u>4700uF 35V</u>
<u>C 2</u>	<u>4700uF 35V</u>
<u>C 4</u>	<u>470uF 63V</u>
<u>C 3</u>	<u>.01uF</u>

