

DAC1 == SPI1 NSS

Sheet: Digital Out

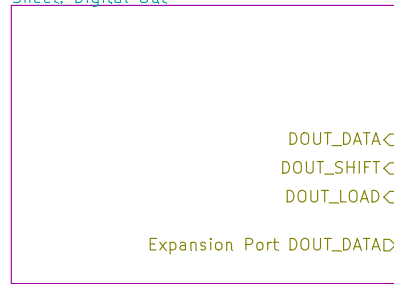

File: dout.sch

Sheet: AVR

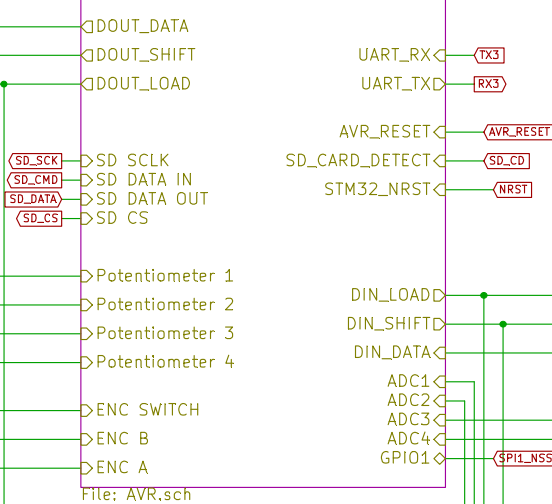

Expansion Header

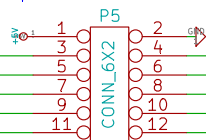

Sheet: Connectors

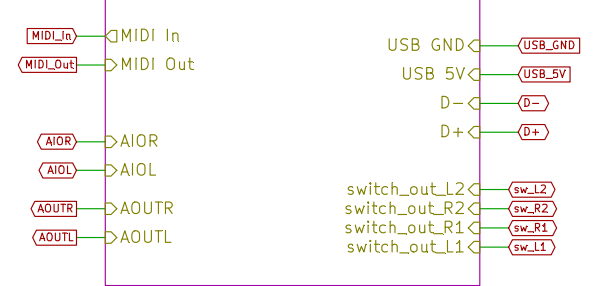

File: connectors.sch

Sheet: encoder and knobs

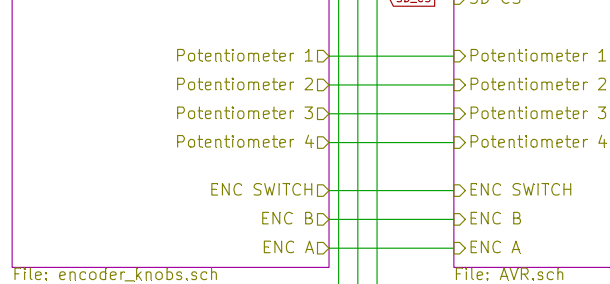

File: encoder_knobs.sch

Sheet: Digital In

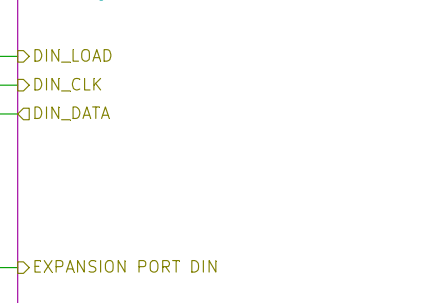

File: din.sch

Sonic Potions
 Julian Schmidt 2013
 This work is licensed under a Creative Commons
Attribution-NonCommercial-ShareAlike 3.0 Unported License.

File: DrumFront.sch

Sheet: /

Title: Frontpanel Drumsynth

Size: A4 Date: 18 apr 2013

KiCad E.D.A. eeschema (2012-01-19 BZR 3256)-stable

Rev: 0.4

Id: 1/6

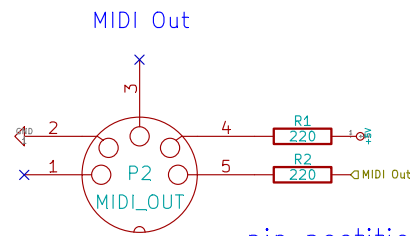
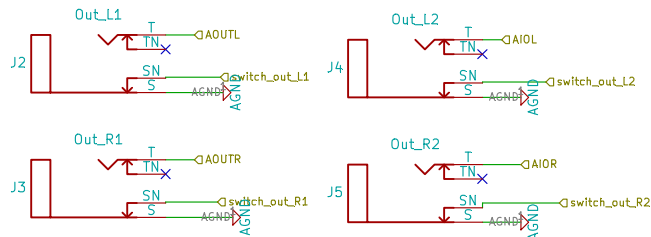
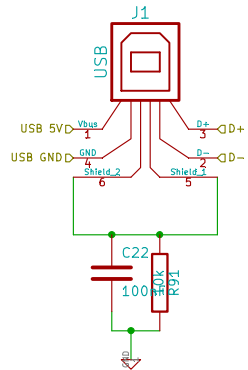

pin positions wrong on symbol.
correct on footprint

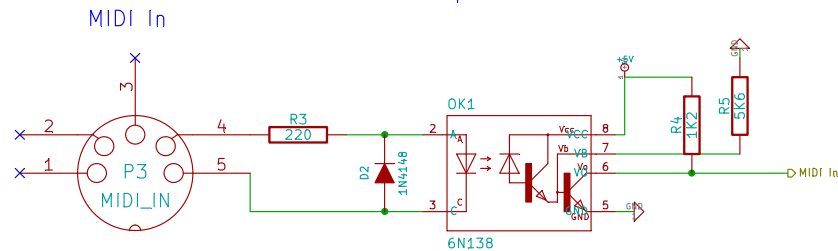

Sonic Potions Julian Schmidt 2013 This work is licensed under a Creative Commons Attribution-NonCommercial-ShareAlike 3.0 Unported License.		
File: connectors.sch Sheet: /Connectors/		
Title: Frontpanel Drumsynth		
Size: A4	Date: 18 apr 2013	Rev: 0.4
KiCad E.D.A. eeschema (2012-01-19 BZR 3256)-stable		Id: 2/6

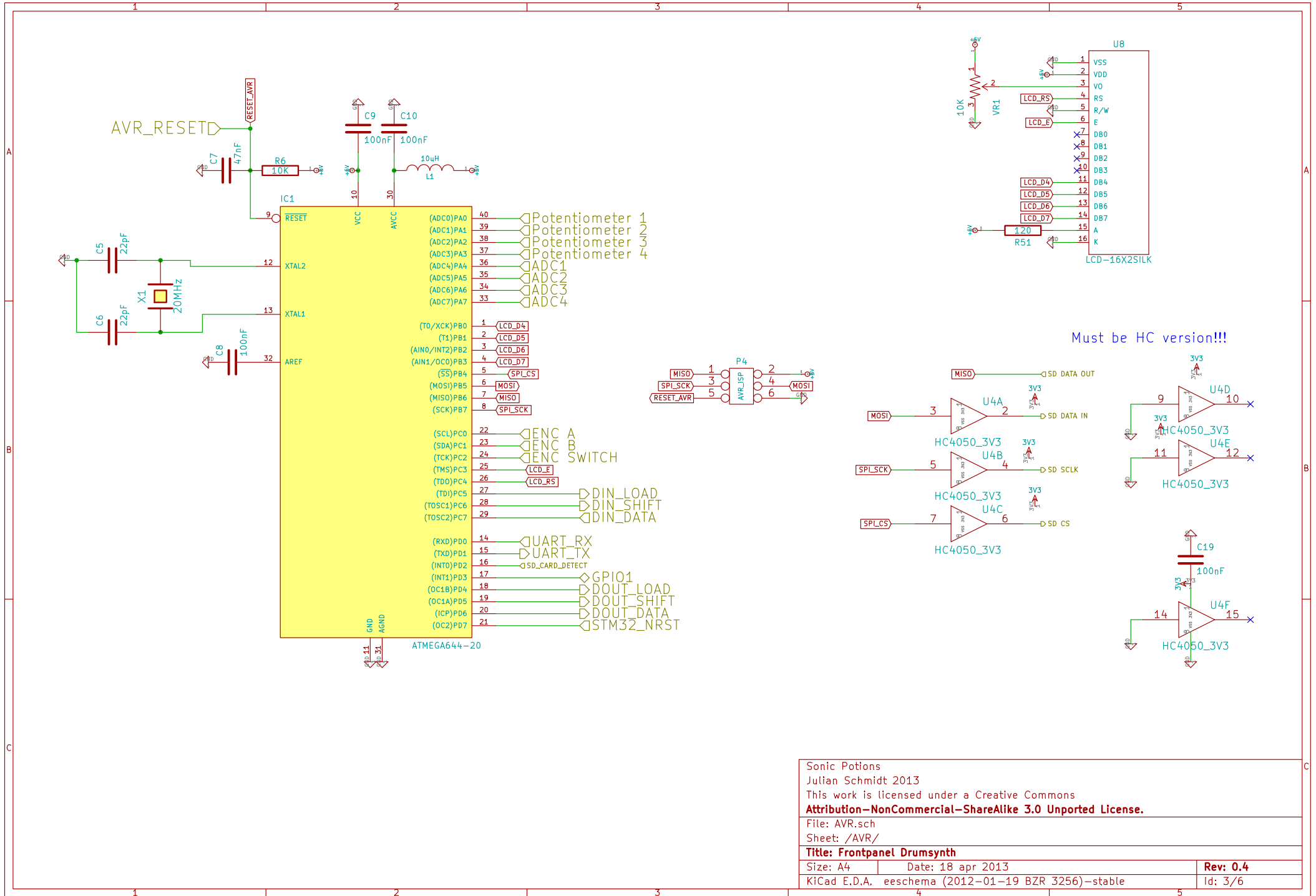

Must be HC version!!!

Sonic Potions Julian Schmidt 2013 This work is licensed under a Creative Commons Attribution-NonCommercial-ShareAlike 3.0 Unported License.		
File: AVR.sch Sheet: /AVR/		
Title: Frontpanel Drumsynth		
Size: A4	Date: 18 apr 2013	Rev: 0.4
KiCad E.D.A. eeschema (2012-01-19 BZR 3256)-stable		Id: 3/6

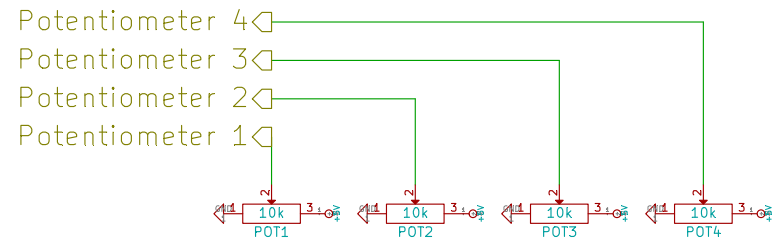
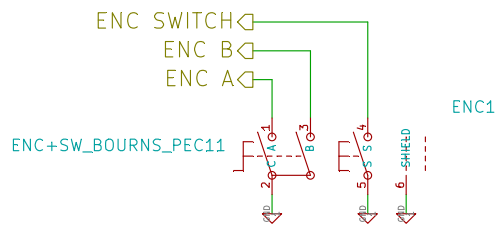

Sonic Potions		
Julian Schmidt 2013		
This work is licensed under a Creative Commons		
Attribution-NonCommercial-ShareAlike 3.0 Unported License.		
File: encoder_knobs.sch		
Sheet: /encoder and knobs/		
Title: Frontpanel Drumsynth		
Size: A4	Date: 18 apr 2013	Rev: 0.4
KiCad E.D.A. eeschema (2012-01-19 BZR 3256)-stable		Id: 4/6

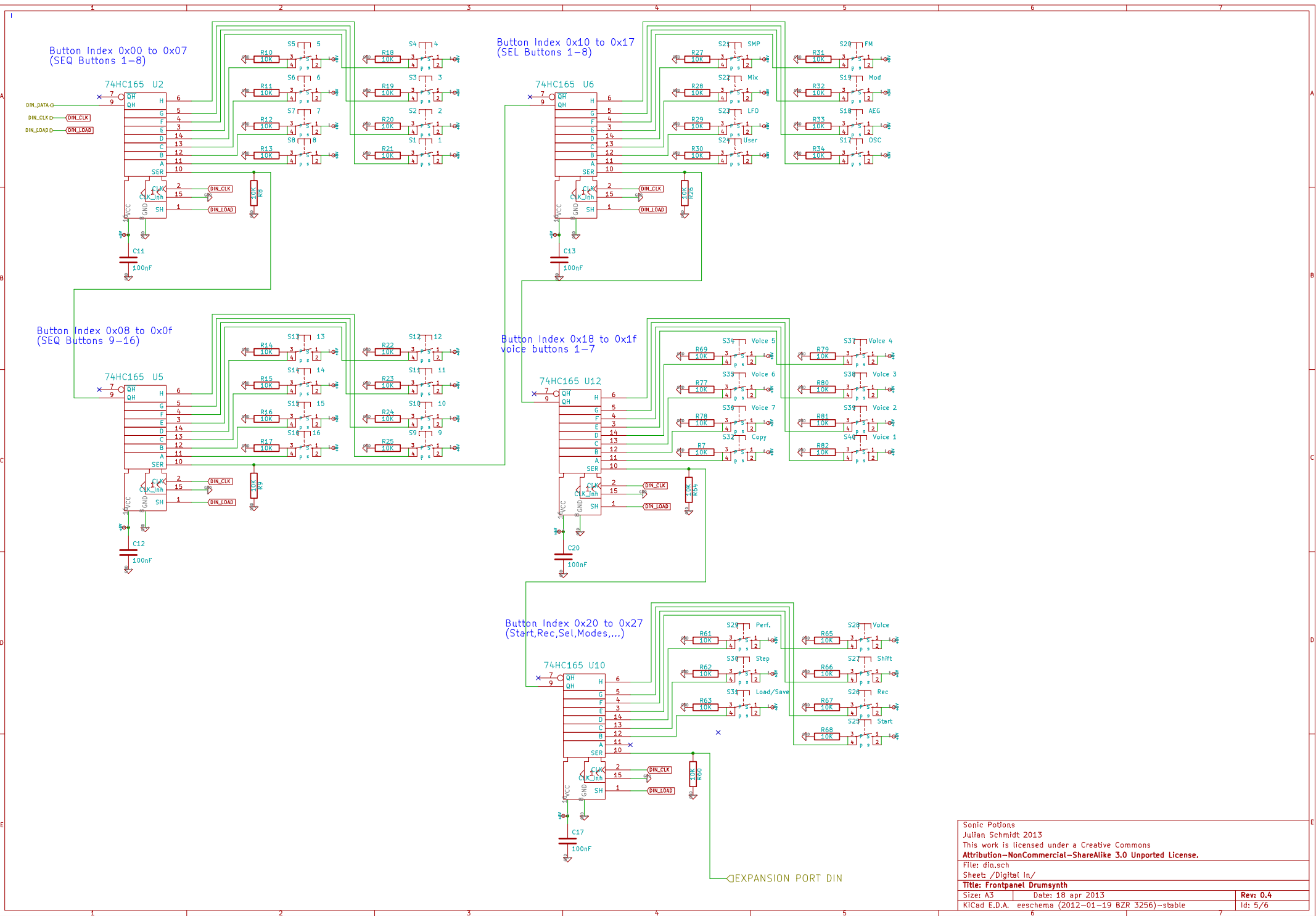

Button Index 0x00 to 0x07
(SEQ Buttons 1-8)

Button Index 0x10 to 0x17
(SEL Buttons 1-8)

Button Index 0x08 to 0x0f
(SEQ Buttons 9-16)

Button Index 0x18 to 0x1f
voice buttons 1-7

Button Index 0x20 to 0x27
(Start, Rec, Sel, Modes, ...)

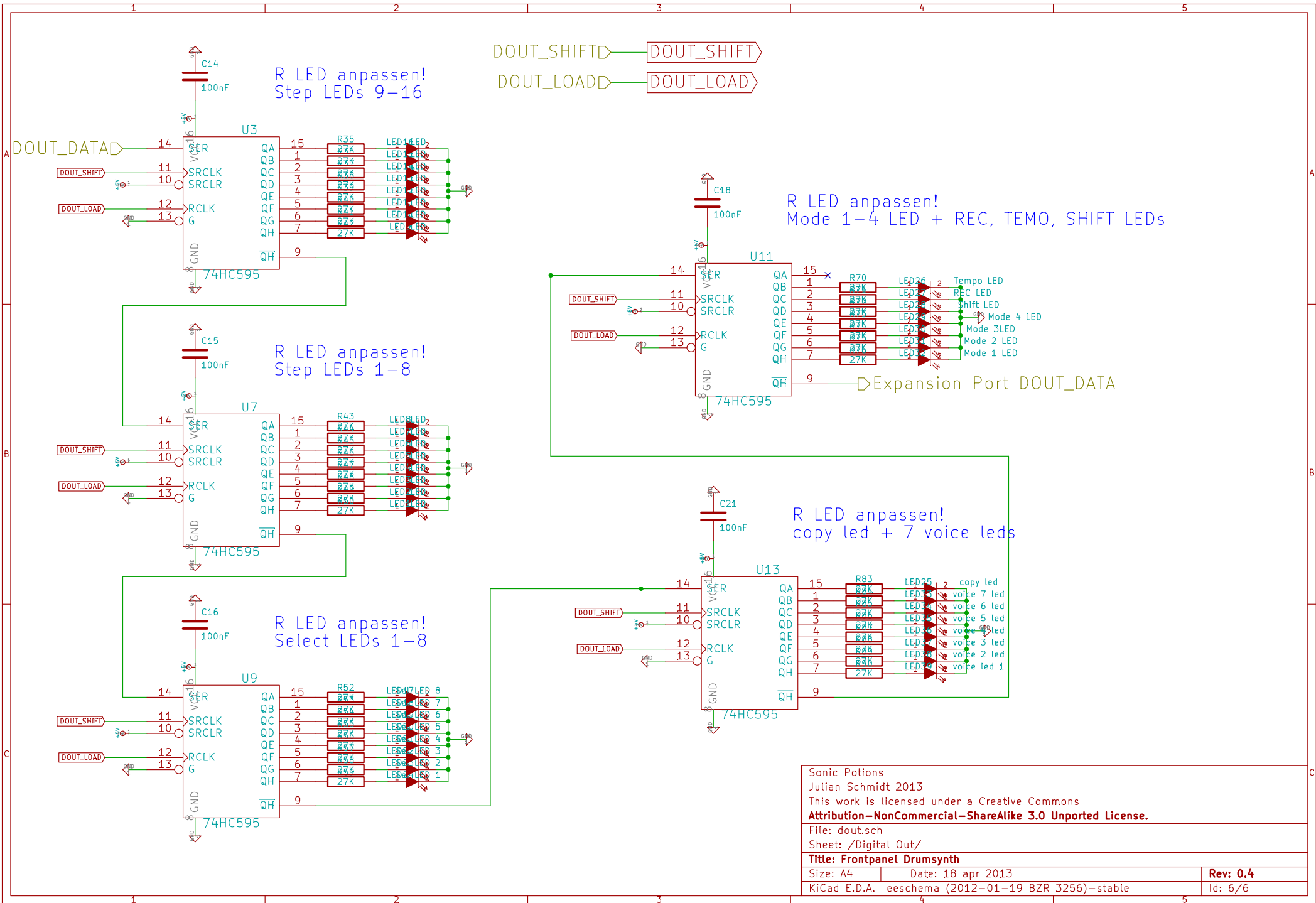

Sonic Potions
 Julian Schmidt 2013
 This work is licensed under a Creative Commons
Attribution–NonCommercial–ShareAlike 3.0 Unported License.
 File: dout.sch
 Sheet: /Digital Out/
Title: Frontpanel Drumsynth
 Size: A4 Date: 18 apr 2013
 KiCad E.D.A. eeschema (2012–01–19 BZR 3256)–stable
Rev: 0.4
 Id: 6/6