

DECKARD'S DREAM

VOICECARD ALL COMPONENTS | LAST UPDATED 01.01.2018

BOMV1.07

VOICE BOARD						
VALUE	DESIGNATOR	QTY (1 CARD)	QTY (8 CARDS)	FOOTPRINT	NOTE	MOUSER PART #
220uF	"C1" "C2" "C3" "C4"	4	32	8MM DIA / 3.5 LS	ELECTROLYTHIC CAPACITOR	667-ECA-1VM221
47uF	"C11" "C82"	2	16	5MM DIA / 2MM LS	ELECTROLYTHIC CAPACITOR	667-ECA-1CM470
1uF	"C30" "C31" "C42" "C77" "C97" "C98" "C109" "C142"	8	64	5MM DIA / 2MM LS	ELECTROLYTHIC NON-POLARIZED CAPACITOR	647-UVP1H010MDD1TD
0.1uF	"C9" "C10" "C19" "C80" "C81" "C90"	58	464	SMT 0805	CERAMIC CAPACITOR	581-0805C104K
0.01uF	"C14" "C15" "C17" "C85" "C86" "C88"	6	48	5MM LS	CERAMIC CAPACITOR	810-FG28COG1H103JNT6
1000pF	"C14" "C15" "C17" "C85" "C86" "C88"	6	48	5MM LS	CERAMIC CAPACITOR	810-FG28COG1H102JNT6
560pF	"C33" "C34" "C36" "C44" "C45" "C48" "C51" "C54" "C62" "C66" "C67" "C70" "C75" "C79" "C100" "C101" "C103" "C111" "C112" "C115" "C118" "C121" "C127" "C131" "C132" "C135" "C140" "C144"	28	224	5MM LS	CERAMIC CAPACITOR	810-FG28COG1H561JNT0
180pF	"C32" "C43" "C99" "C110"	4	32	5MM LS	CERAMIC CAPACITOR	810-FG28COG1H181JNT6
100pF	"C52" "C53" "C59" "C63" "C64" "C65" "C68" "C69" "C76" "C78" "C119" "C120" "C124" "C128" "C129" "C130" "C133" "C134" "C141" "C143"	20	160	5MM LS	CERAMIC CAPACITOR	810-FG28COG1H101JNT6
1.5nF	"C28" "C29" "C38" "C39" "C95" "C96" "C105" "C106"	8	64	5MM LS	FILM CAPACITOR	80-R82EC1150AA50J
CEM3340	"IC1" "IC16"	2	16	DIP16	VOLTAGE CONTROLLED OSCILLATOR	http://synthcube.com/cart/ddrm-onchip-chem3340-x-17
TL074	"IC2" "IC6" "IC7" "IC12" "IC14" "IC17" "IC19" "IC20" "IC25" "IC26"	10	80	DIP14	QUAD OPERATIONAL AMPLIFIER	595-TL074CN
74LS74	"IC3"	1	8	DIP14	POSITIVE EDGE TRIGGERED FLIP FLOP	595-SN74LS74AN
DG403	"IC4"	1	8	DIP16	SPDT CMOS ANALOG SWITCH	781-DG403DJ-E3
DG202	"IC5"	1	8	DIP16	SPST CMOS ANALOG SWITCH	781-DG202BDJ-E3
TL072	"IC8" "IC11" "IC21" "IC24"	4	32	DIP8	DUAL OPERATIONAL AMPLIFIER	595-TL072IP
V2164	"IC9" "IC10" "IC13" "IC15" "IC22" "IC23" "IC27"	7	56	DIP16	QUAD VOLTAGE CONTROLLED AMPLIFIER	http://synthcube.com/cart/ddrm-60x-v2164-ic
2N3904	"Q1" "Q2" "Q3" "Q4"	4	32	TO-92	NPN TRANSISTOR	610-2N3904
4M7	"R52" "R53" "R67" "R68" "R158" "R159" "R173" "R174"	2	64		1/4W 1% RESISTOR	603-MFR-25FRF52-4M7
1M5	"R5" "R111"	8	16		1/4W 1% RESISTOR	271-1.5M-RC
1M2	"R60" "R74" "R166" "R180"	4	32		1/4W 1% RESISTOR	603-MFR-25FRF52-1M2
1M	"R37" "R143"	2	16		1/4W 1% RESISTOR	271-1.0M-RC
300K	"R6" "R112"	2	16		1/4W 1% RESISTOR	271-300K-RC
150K	"R56" "R59" "R61" "R69" "R162" "R165" "R167" "R175"	8	64		1/4W 1% RESISTOR	271-150K-RC
120K	"R88" "R194"	2	16		1/4W 1% RESISTOR	271-120K-RC
107K	"R24" "R130"	2	16		1/4W 1% RESISTOR	271-107K-RC
100K	"R18" "R28" "R41" "R43" "R44" "R46" "R48" "R49" "R124" "R134" "R147" "R149" "R150" "R152" "R154" "R155"	16	128		1/4W 1% RESISTOR	271-100K-RC
73K2	"R19" "R125"	2	16		1/4W 1% RESISTOR	271-73.2K-RC
47K	"R1" "R17" "R107" "R123"	4	32		1/4W 1% RESISTOR	271-47K-RC
33K	"R50" "R51" "R54" "R55" "R62" "R64" "R65" "R66" "R70" "R71" "R75" "R77" "R156" "R157" "R160" "R161" "R168" "R170" "R171" "R172" "R176" "R177" "R181" "R183"	24	192		1/4W 1% RESISTOR	271-33K-RC
31K6	"R25" "R131"	2	16		1/4W 1% RESISTOR	603-MFR-25FRF52-31K6
30K	"R16" "R78" "R81" "R83" "R84" "R85" "R86" "R90" "R91" "R92" "R93" "R95" "R98" "R99" "R100" "R101" "R104" "R105" "R106" "R122" "R184" "R187" "R189" "R190" "R191" "R192" "R196" "R197" "R198" "R199" "R201" "R204" "R205" "R206" "R207" "R210" "R211" "R212"	38	304		1/4W 1% RESISTOR	271-30K-RC
28K7	"R32" "R138"	2	16		1/4W 1% RESISTOR	271-28.7K-RC
24K9	"R20" "R21" "R126" "R127"	4	32		1/4W 1% RESISTOR	271-24.9K-RC
15K	"R94" "R200"	2	16		1/4W 1% RESISTOR	271-15K-RC
12K	"R42" "R47" "R148" "R153"	4	32		1/4W 1% RESISTOR	271-12K-RC
10K	"R2" "R3" "R4" "R9" "R11" "R22" "R23" "R26" "R27" "R34" "R38" "R108" "R109" "R110" "R115" "R117" "R128" "R129" "R132" "R133" "R140" "R144"	22	176		1/4W 1% RESISTOR	271-10K-RC
8K2	"R82" "R188"	2	16		1/4W 1% RESISTOR	271-8.2K-RC
5K6	"R33" "R139"	2	16		1/4W 1% RESISTOR	271-5.6K-RC
4K99	"R30" "R136"	2	16		1/4W 1% RESISTOR	271-4.99K-RC
3K6	"R29" "R135"	2	16		1/4W 1% RESISTOR	271-3.6K-RC
2K49	"R10" "R116"	2	16		1/4W 1% RESISTOR	271-2.49K-RC
2K2	"R13" "R14" "R119" "R120"	4	32		1/4W 1% RESISTOR	271-2.2K-RC
2K	"R36" "R142"	2	16		1/4W 1% RESISTOR	271-2K-RC
1K8	"R35" "R141"	2	16		1/4W 1% RESISTOR	271-1.8K-RC
1K	"R12" "R31" "R118" "R137"	4	32		1/4W 1% RESISTOR	271-1K-RC
820R	"R39" "R145"	2	16		1/4W 1% RESISTOR	271-820-RC
499R	"R57" "R58" "R63" "R72" "R73" "R76" "R79" "R80" "R87" "R89" "R96" "R97" "R102" "R103" "R163" "R164" "R169" "R178" "R179" "R182" "R185" "R186" "R193" "R195" "R202" "R203" "R208" "R209"	28	224		1/4W 1% RESISTOR	271-499-RC
470R	"R7" "R8" "R113" "R114"	4	32		1/4W 1% RESISTOR	271-470-RC
390R	"R15" "R121"	2	16		1/4W 1% RESISTOR	271-390-RC
1N5221	"Z1" "Z2" "Z4" "Z5" "Z9" "Z10" "Z12" "Z13"	8	64	DO-35	ZENER DIODE 2.4V	78-1N5221B
1N5817	"Z3" "Z6" "Z7" "Z8" "Z11" "Z14" "Z15"	7	56	DO-35	SCHOTTKY BARRIER RECTIFIER	511-1N5817

VOICECARD | SMT CAPACITOR

0.1uF

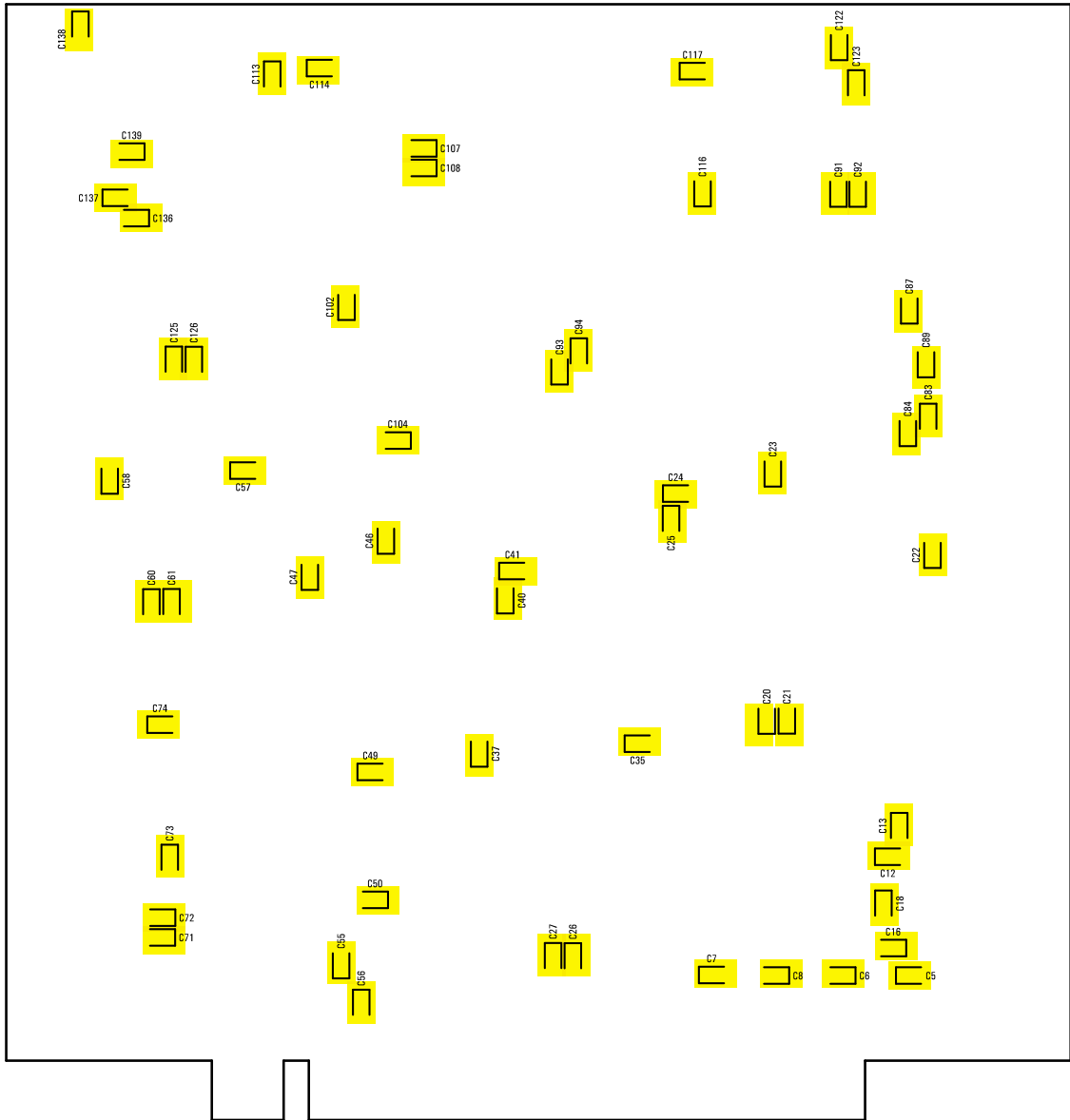

DECKARD'S DREAM

VOICECARD | DIODE

1N5221

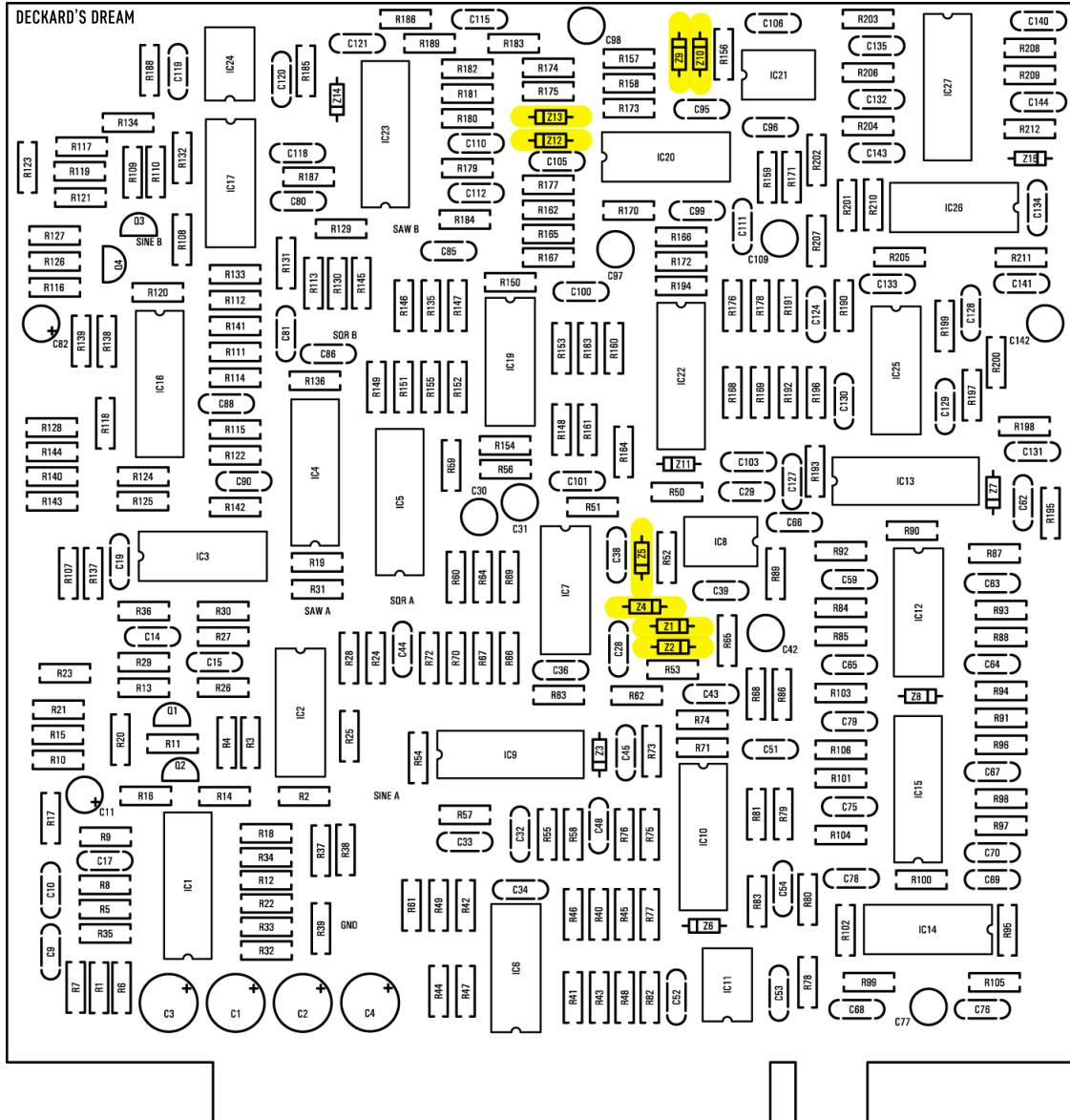

VOICECARD | DIODE

1N5817

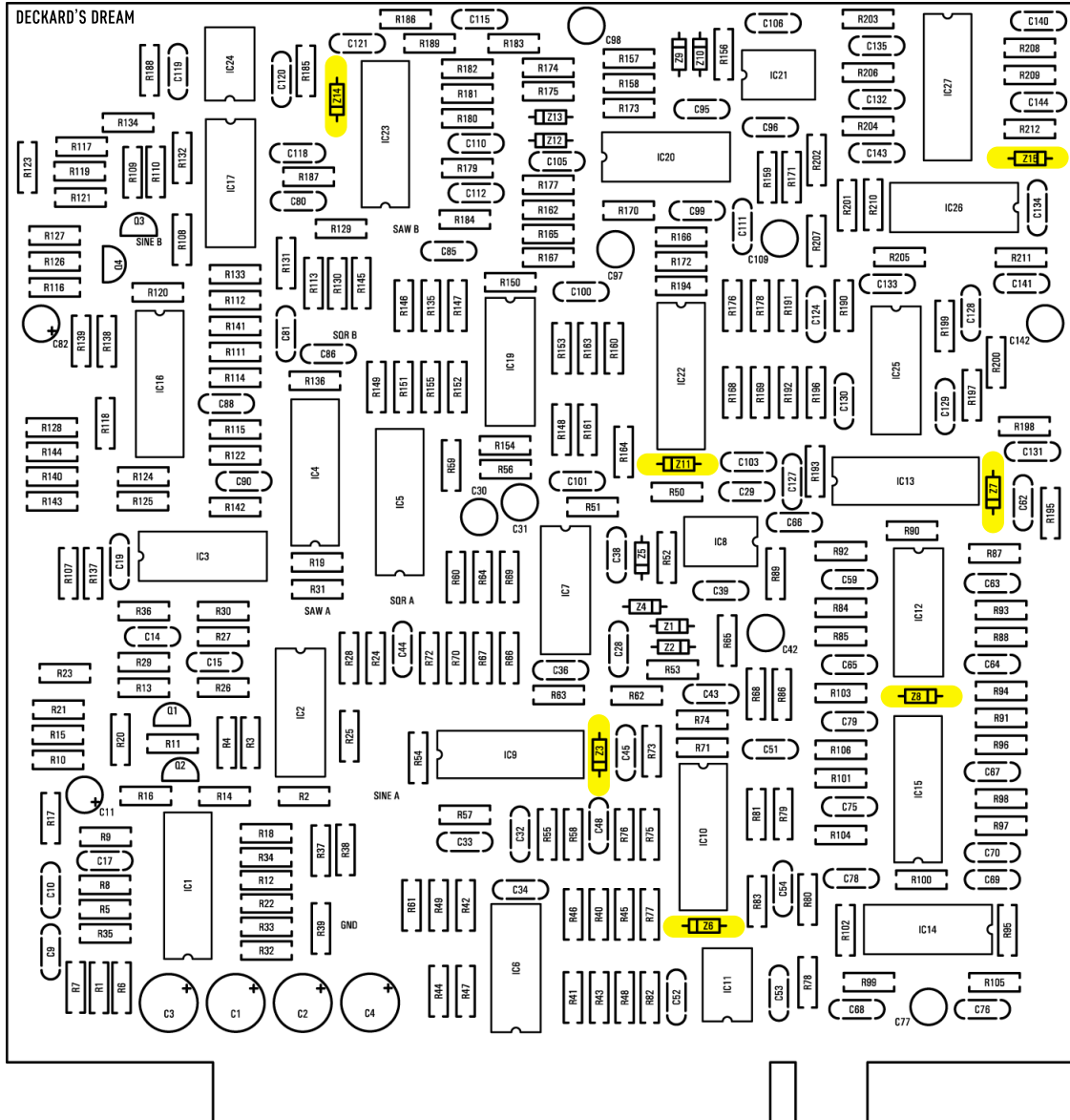

DECKARD'S DREAM

VOICECARD | RESISTOR

4M7

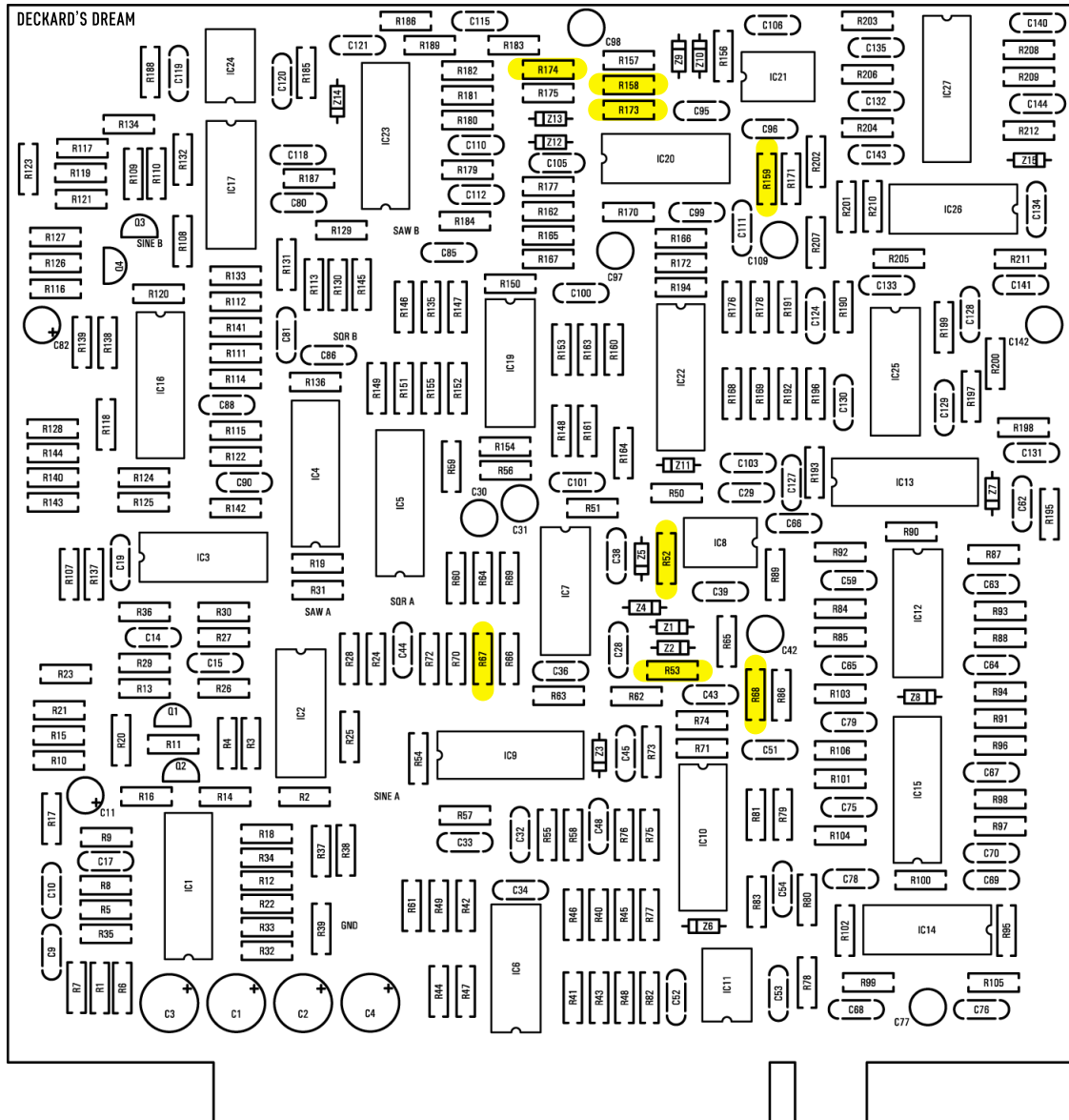

DECKARD'S DREAM

VOICECARD | RESISTOR

1M5

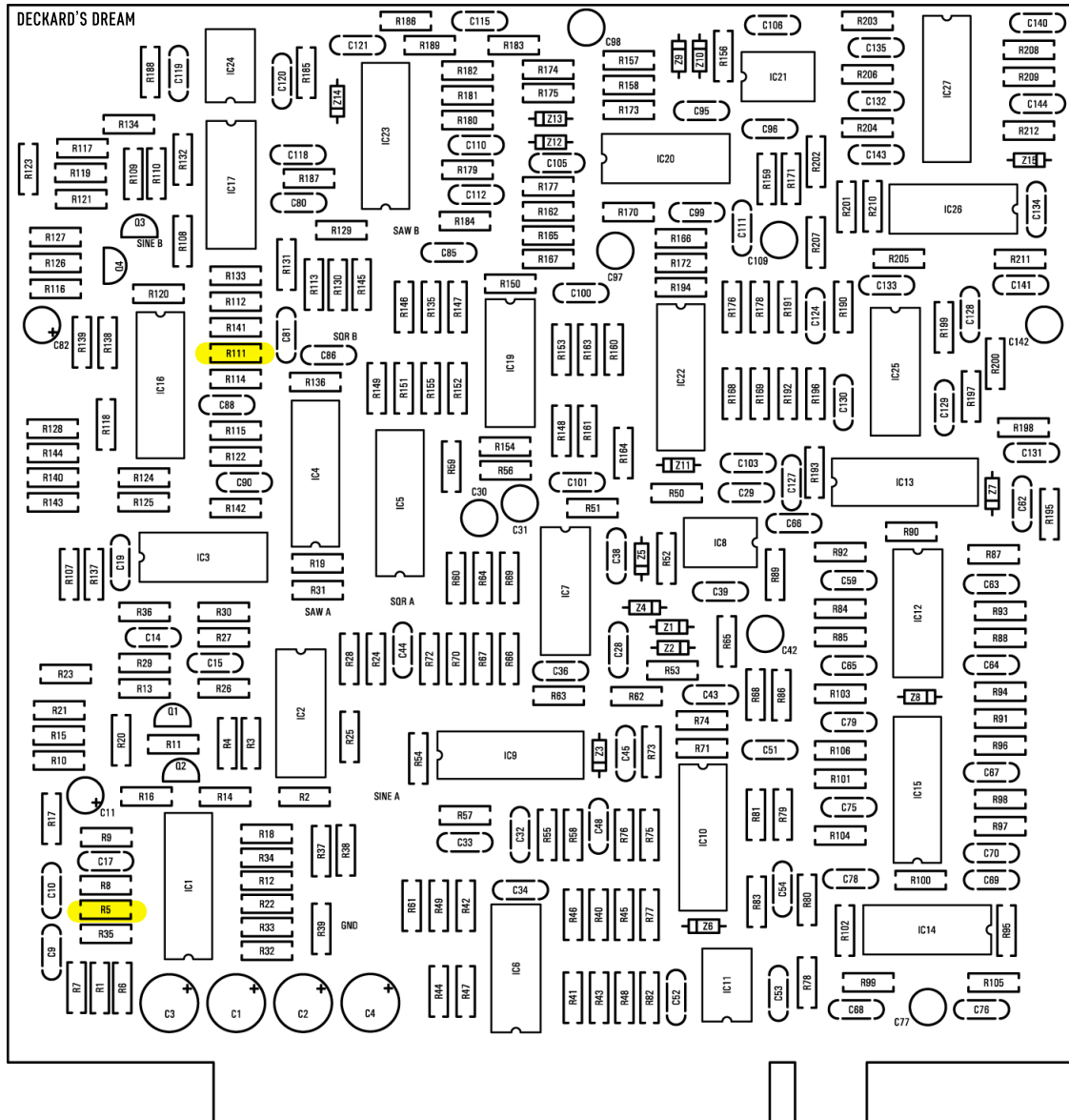

DECKARD'S DREAM

VOICECARD | RESISTOR

1M2

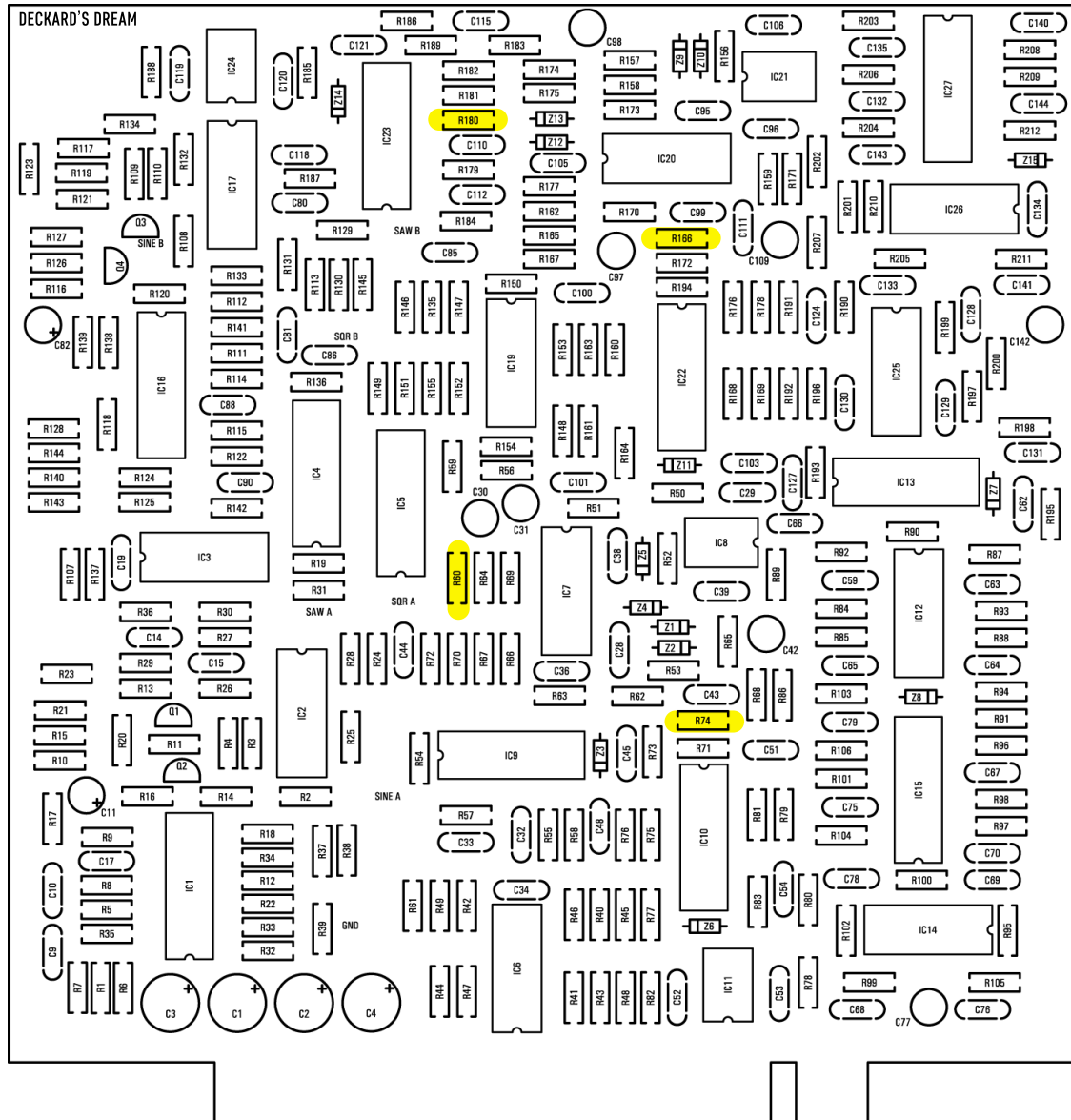

DECKARD'S DREAM

VOICECARD | RESISTOR

1M

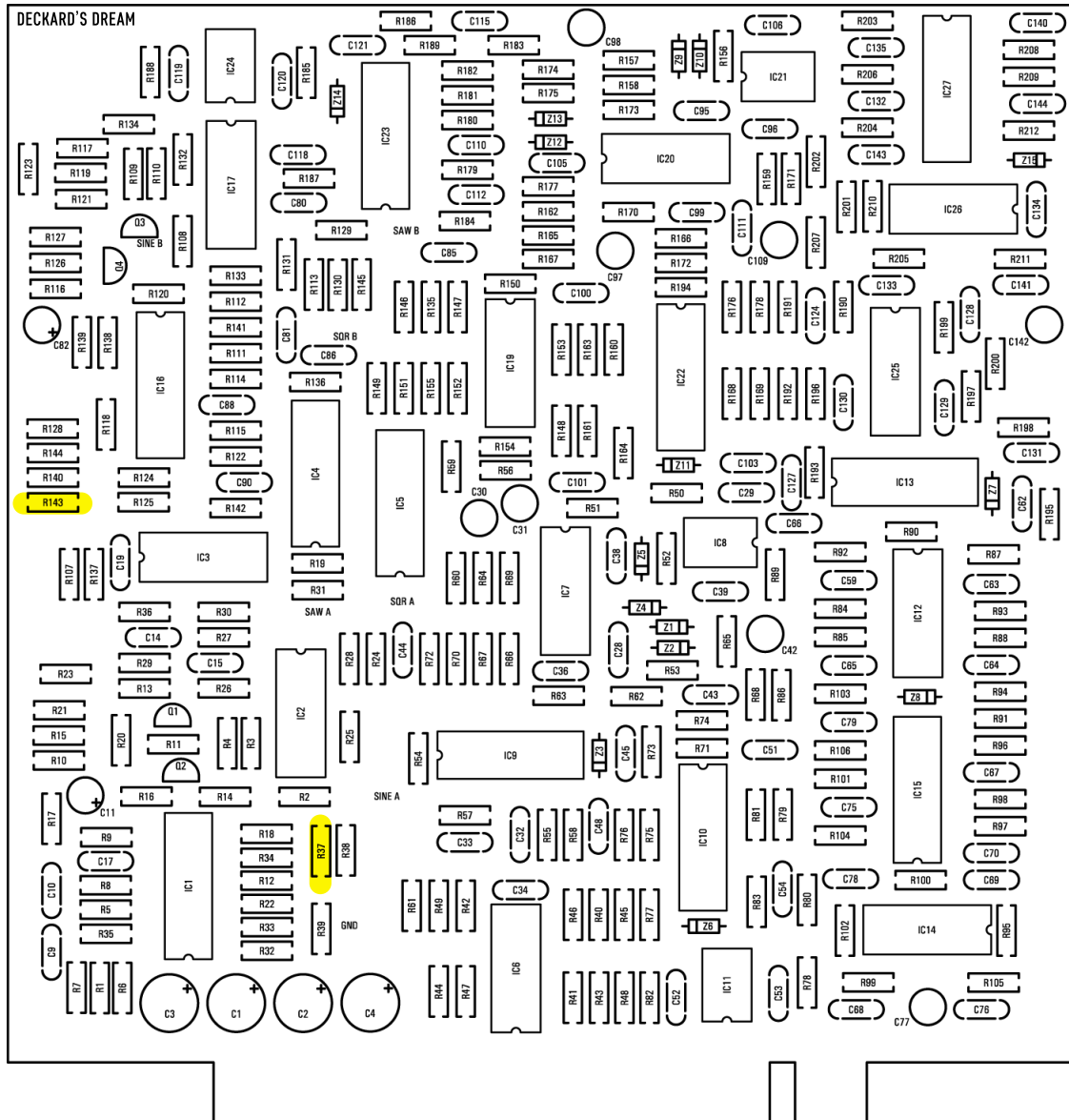

DECKARD'S DREAM

VOICECARD | RESISTOR

300K

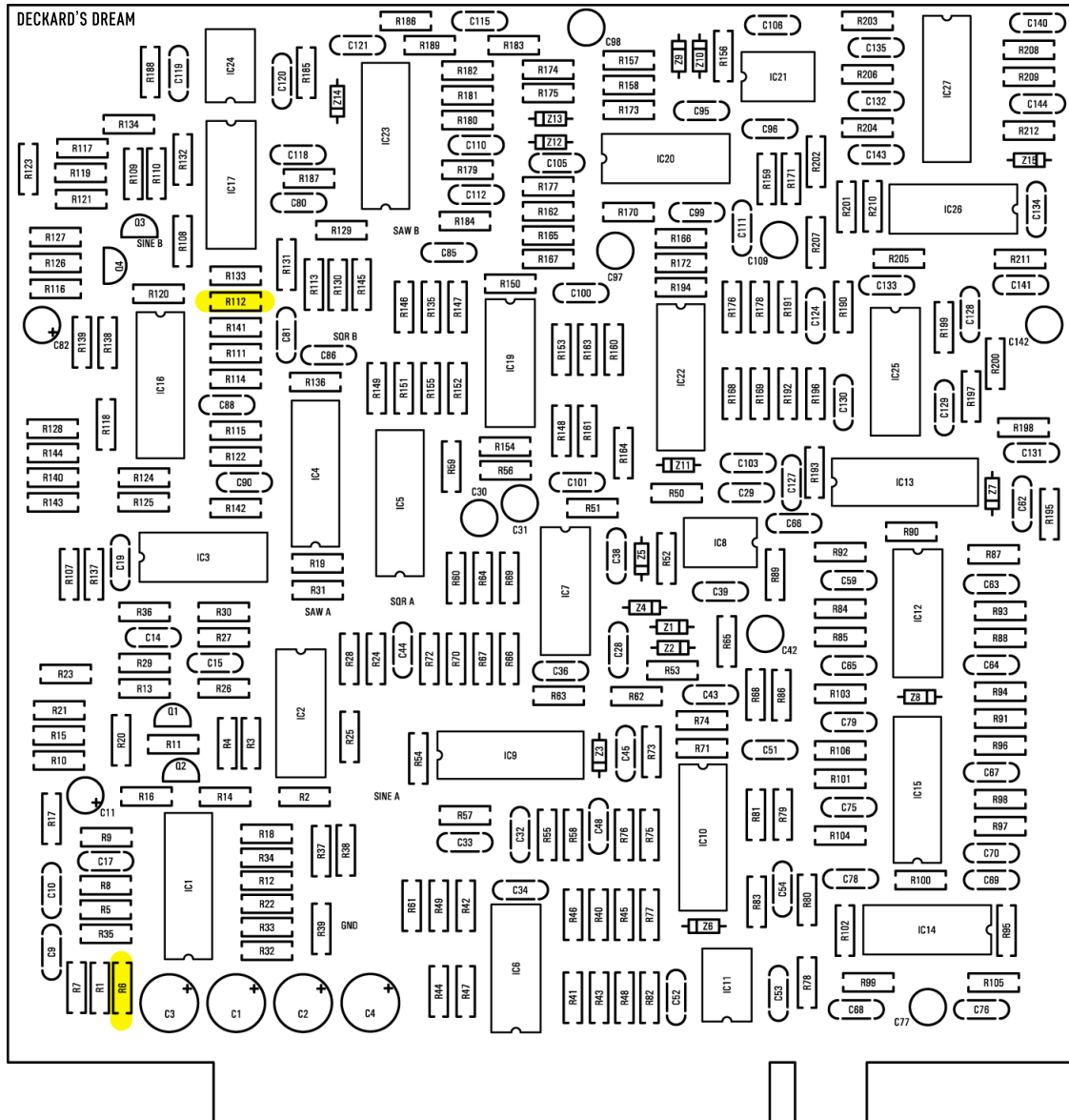

DECKARD'S DREAM

VOICECARD | RESISTOR

150K

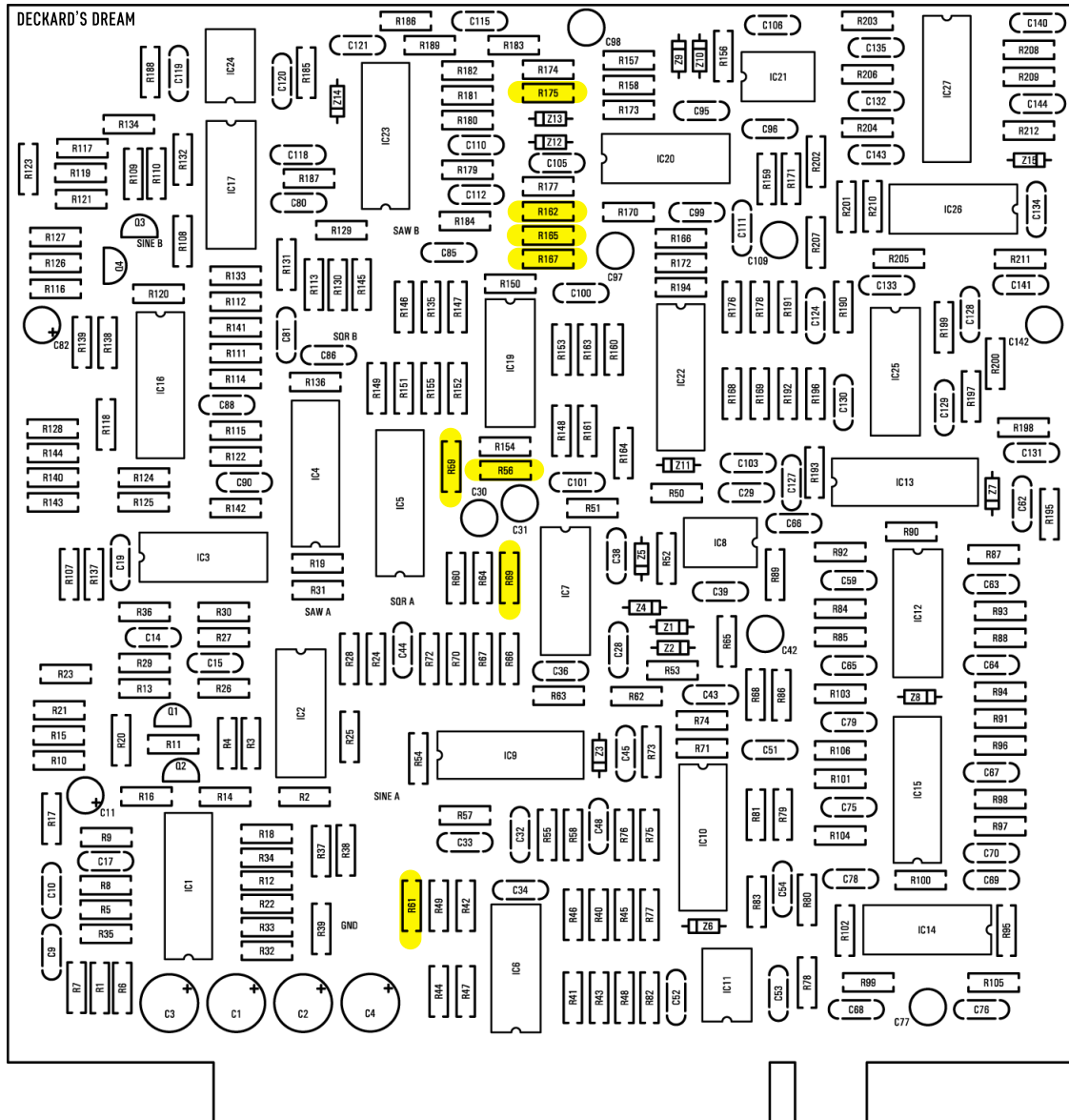

DECKARD'S DREAM

VOICECARD | RESISTOR

120K

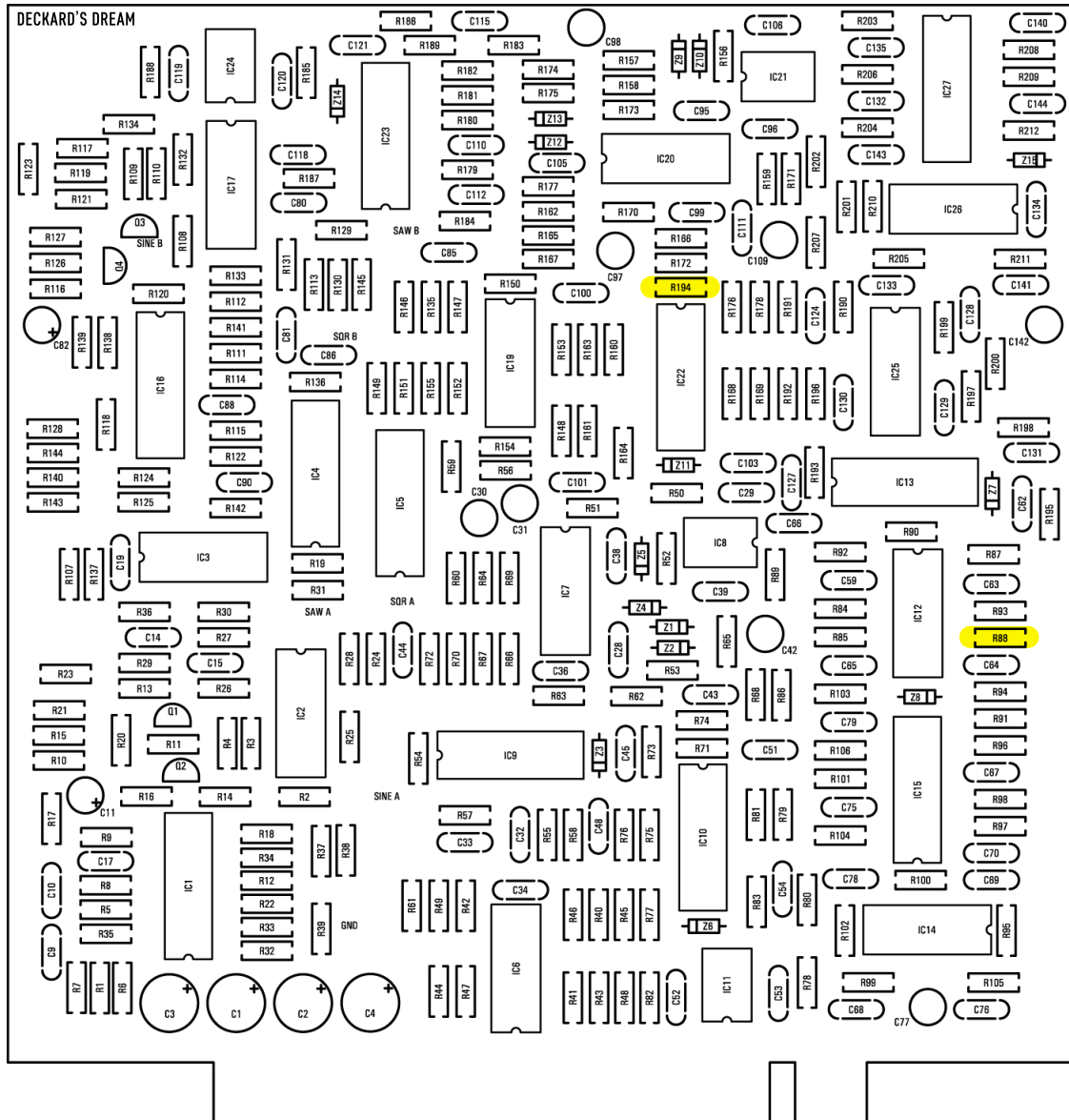

DECKARD'S DREAM

VOICECARD | RESISTOR

107K

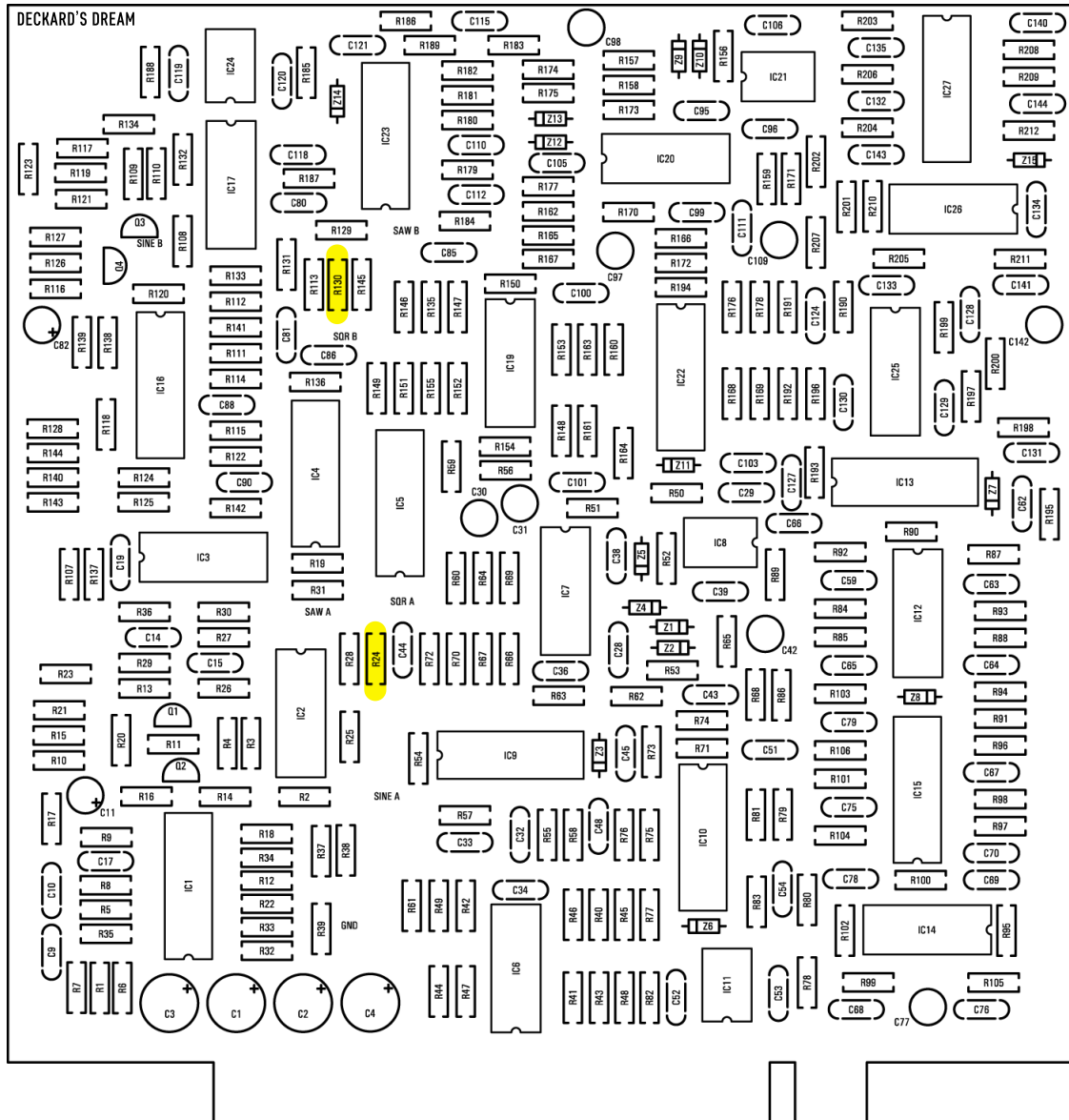

DECKARD'S DREAM

VOICECARD | RESISTOR

100K

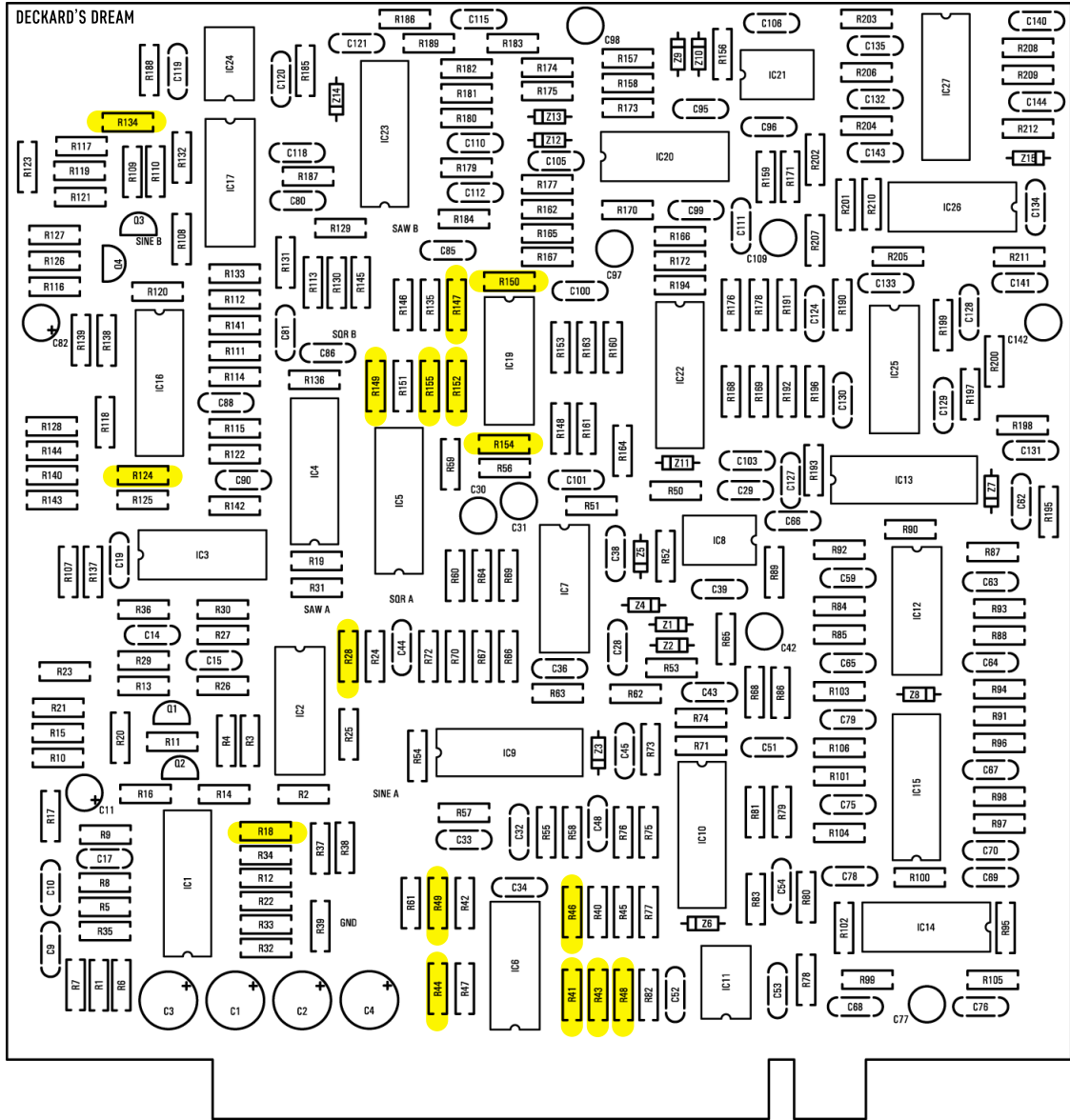

DECKARD'S DREAM

VOICECARD | RESISTOR

47K

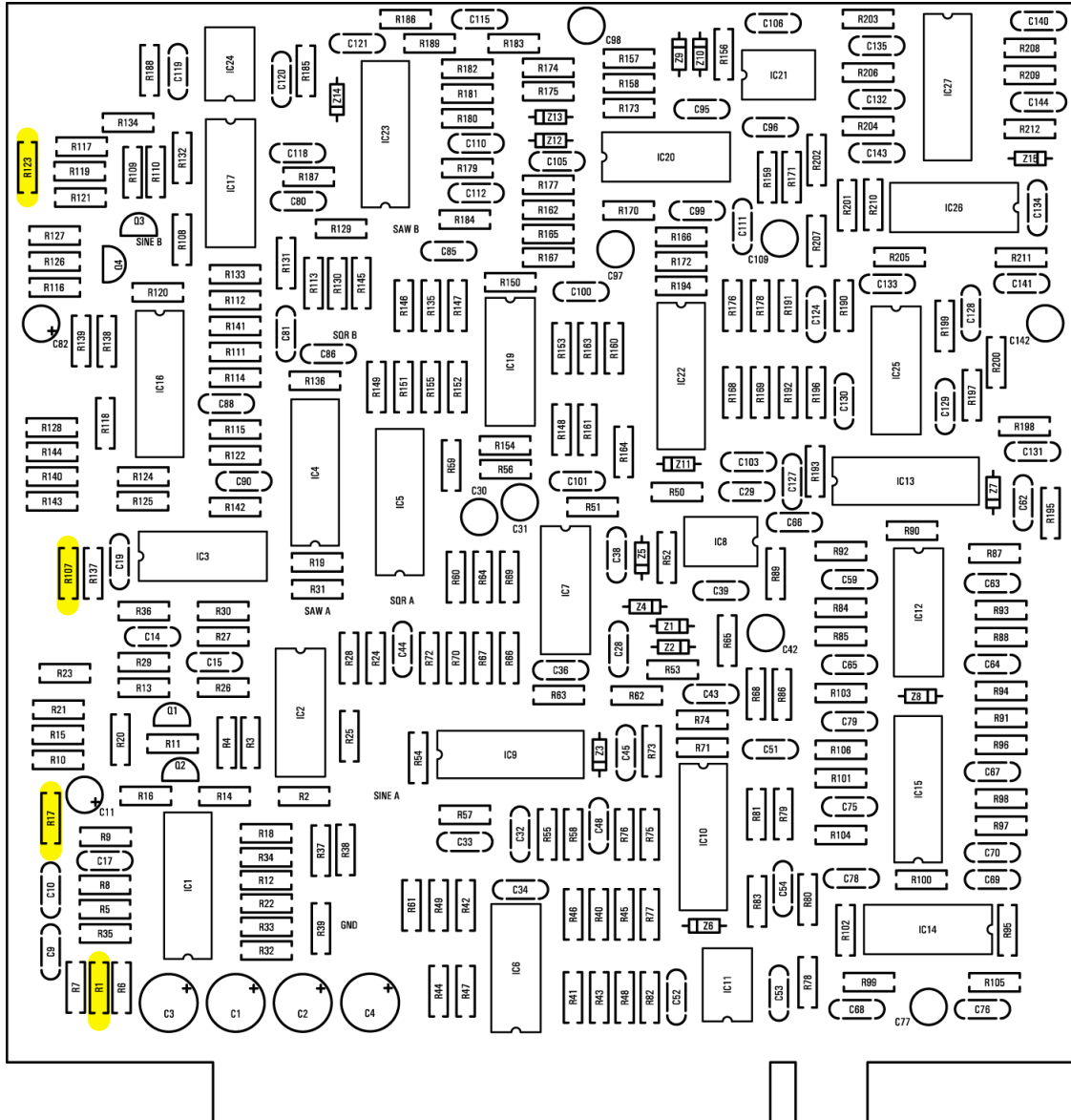

DECKARD'S DREAM

VOICECARD | RESISTOR

73K2

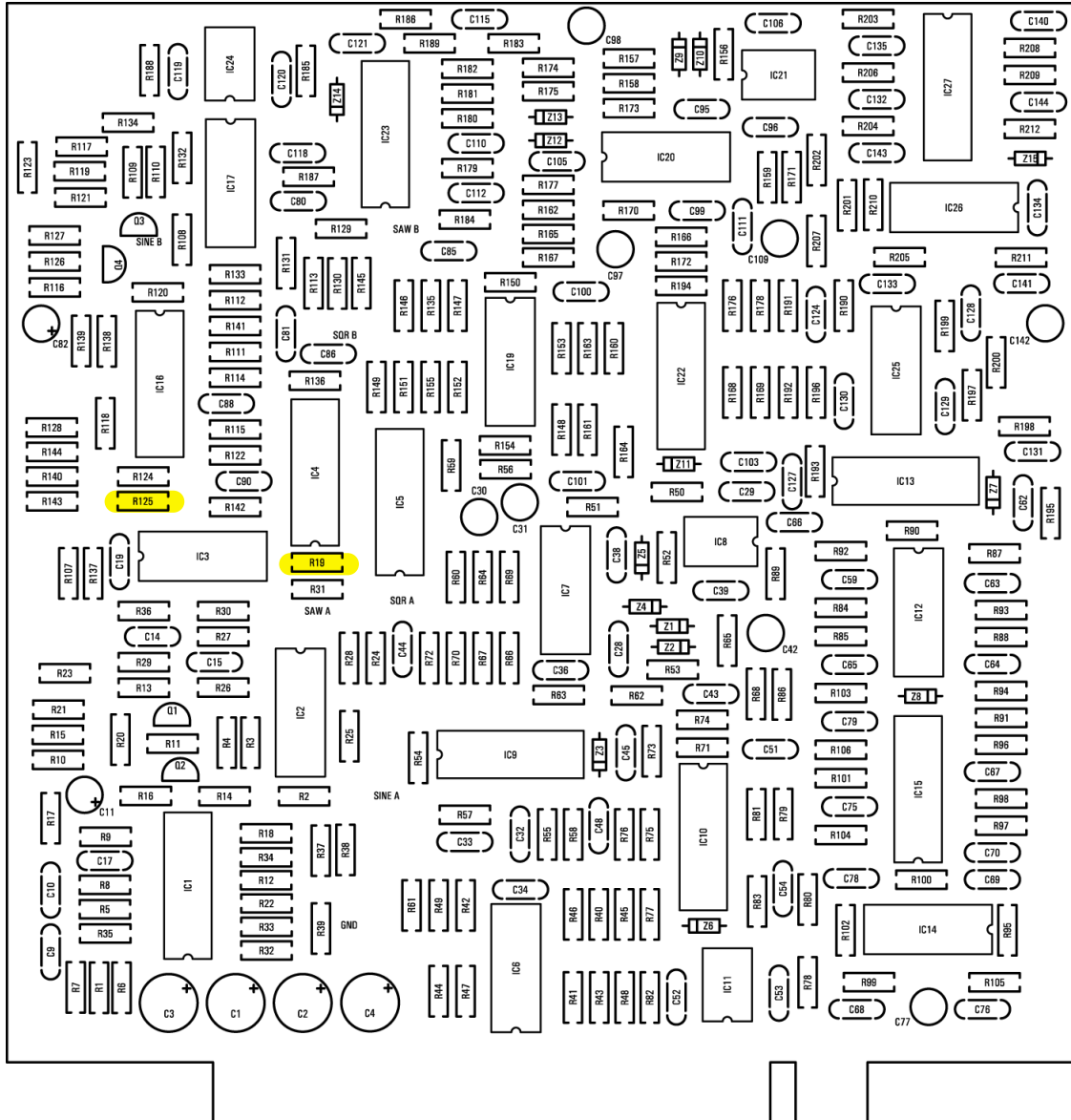

DECKARD'S DREAM

VOICECARD | RESISTOR

33K

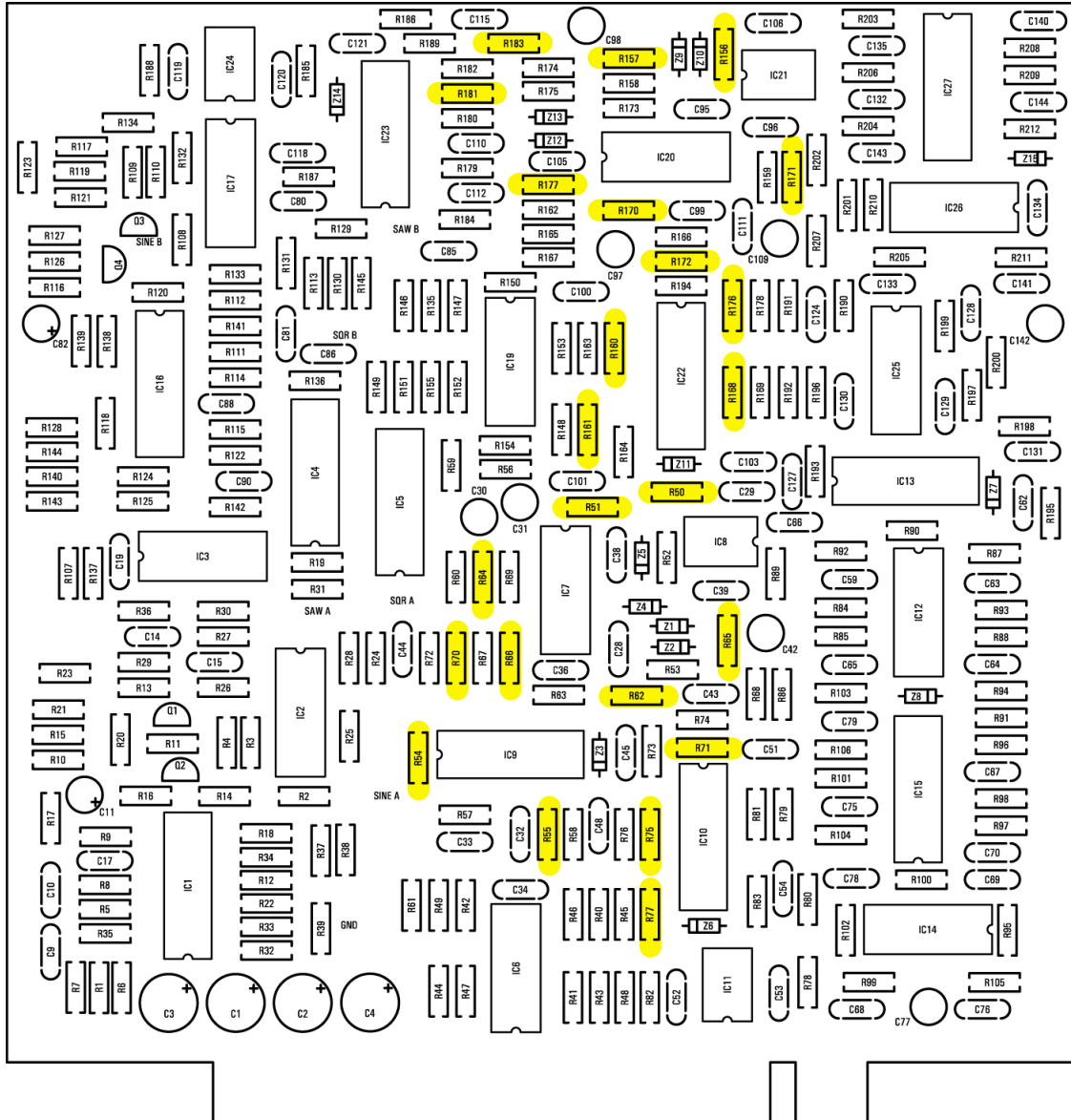

DECKARD'S DREAM

VOICECARD | RESISTOR

31K6

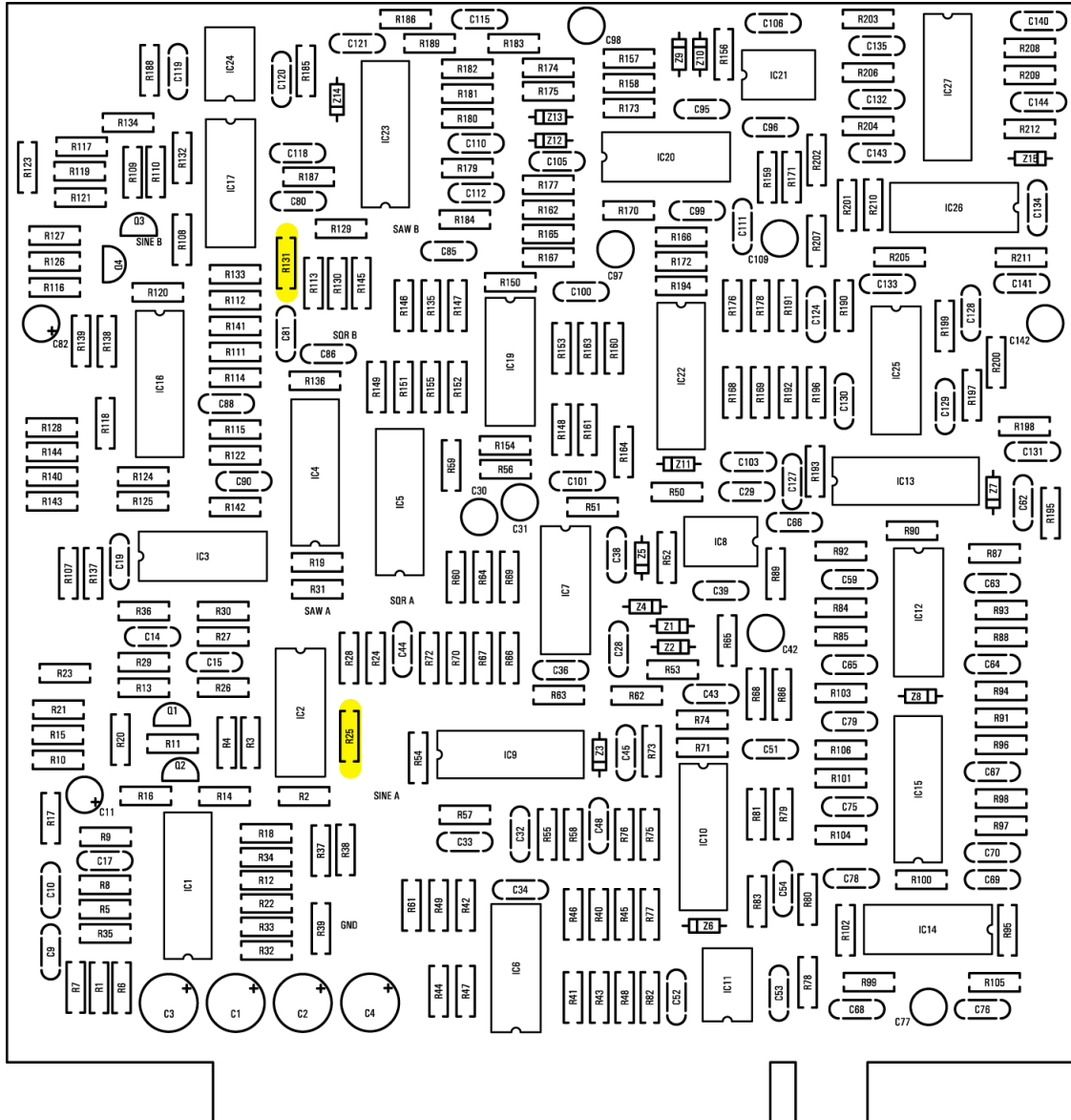

DECKARD'S DREAM

VOICECARD | RESISTOR

30K

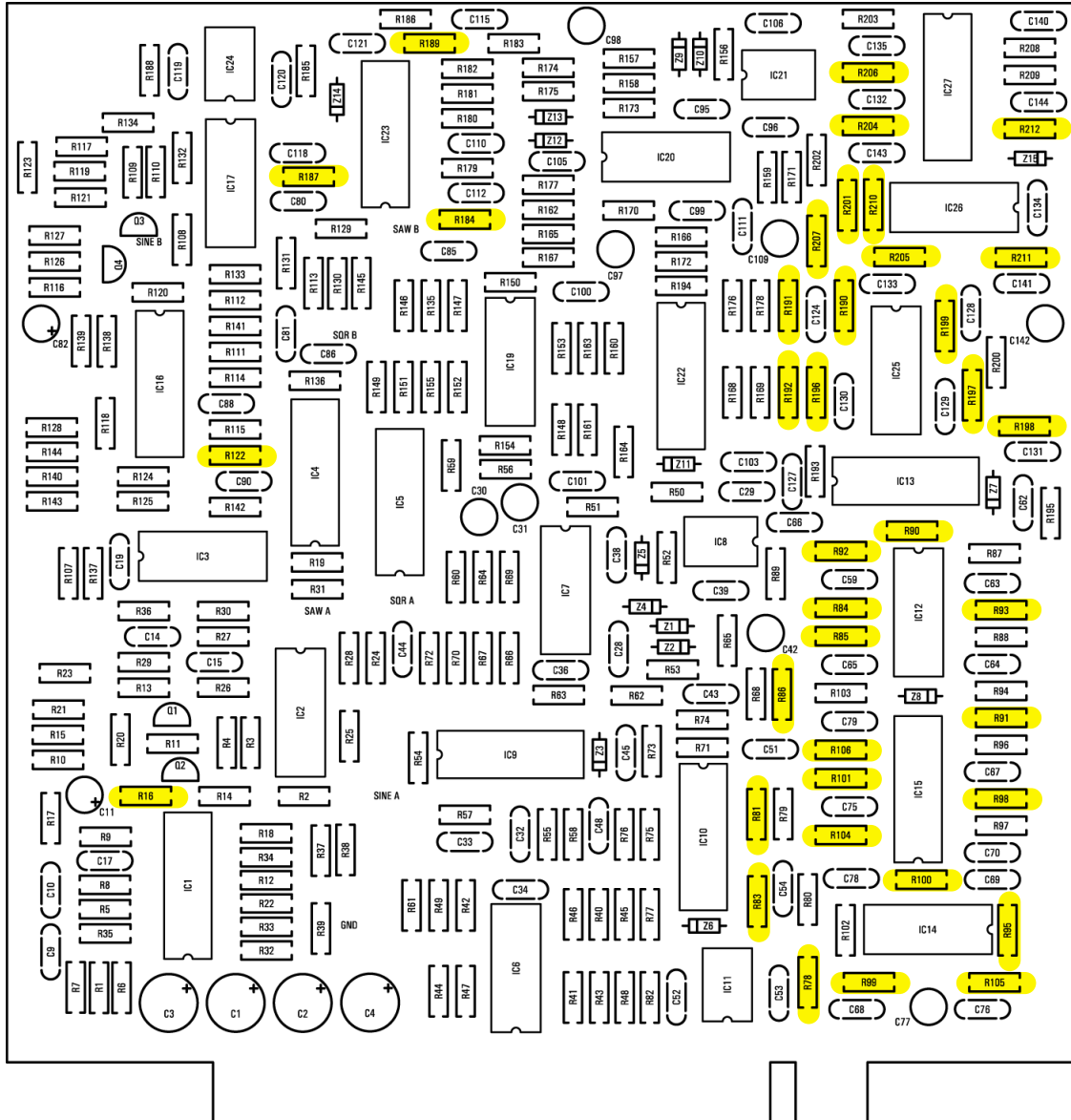

DECKARD'S DREAM

VOICECARD | RESISTOR

28K7

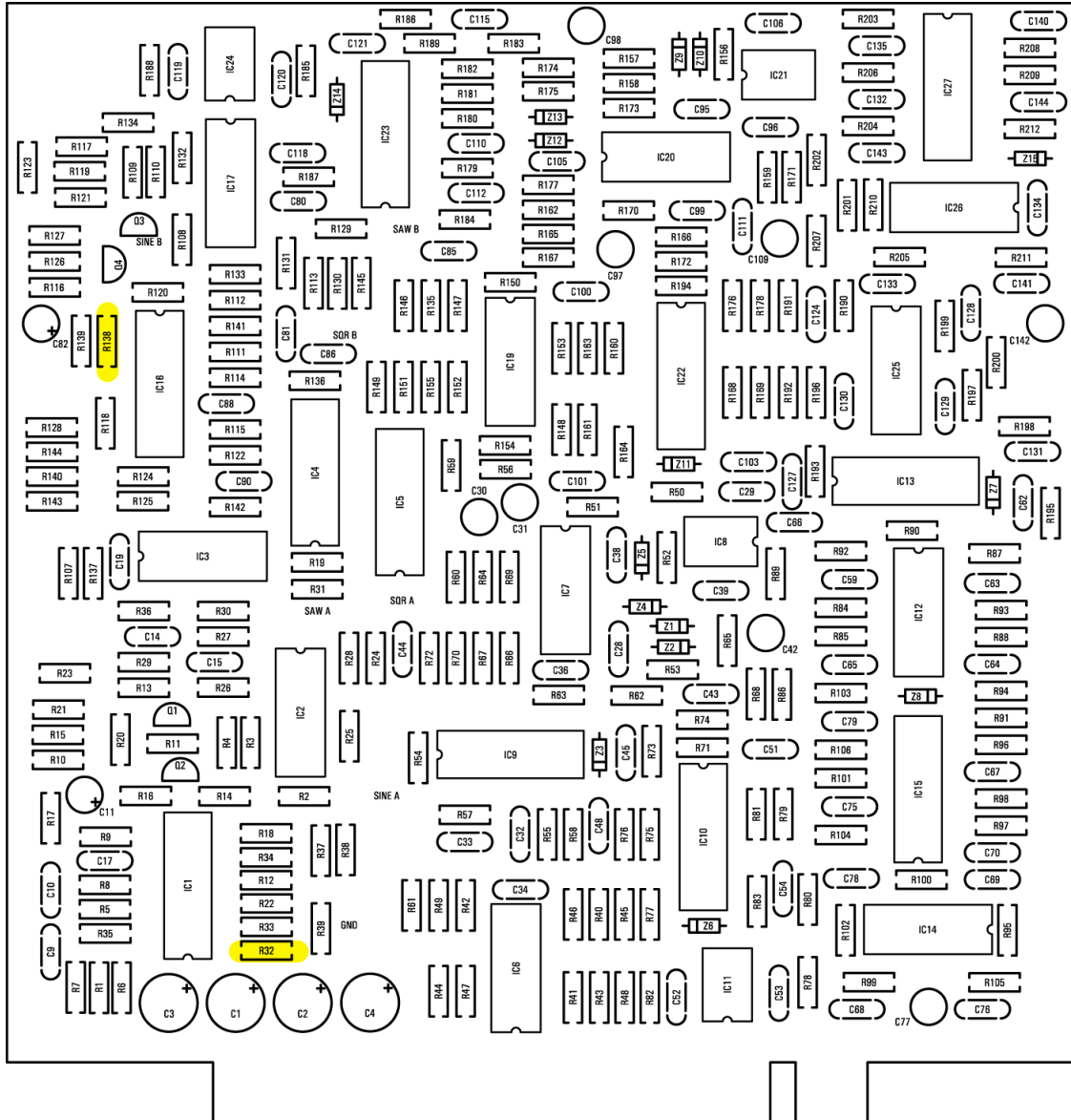

DECKARD'S DREAM

VOICECARD | RESISTOR

24K9

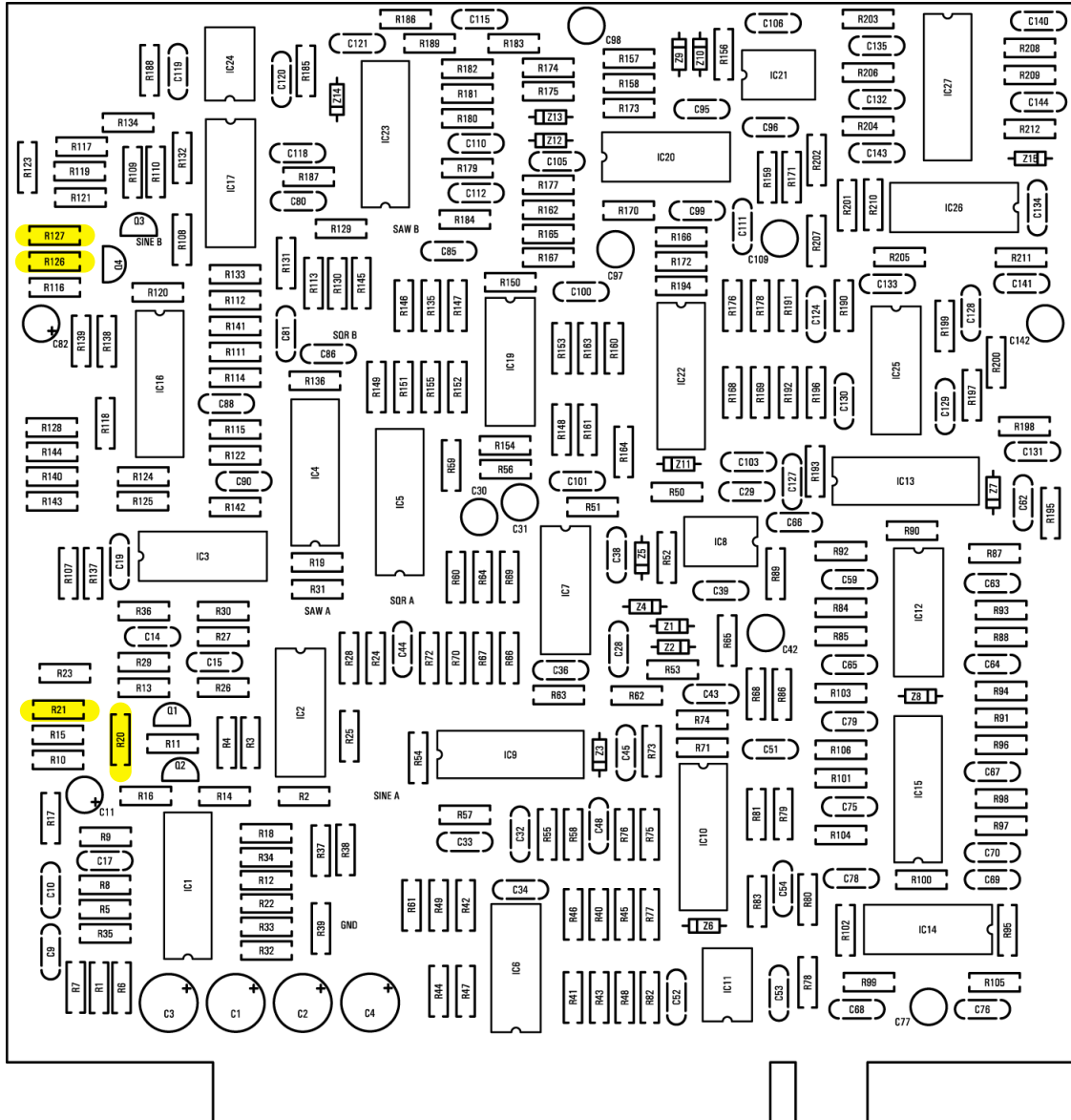

VOICECARD | RESISTOR

15K

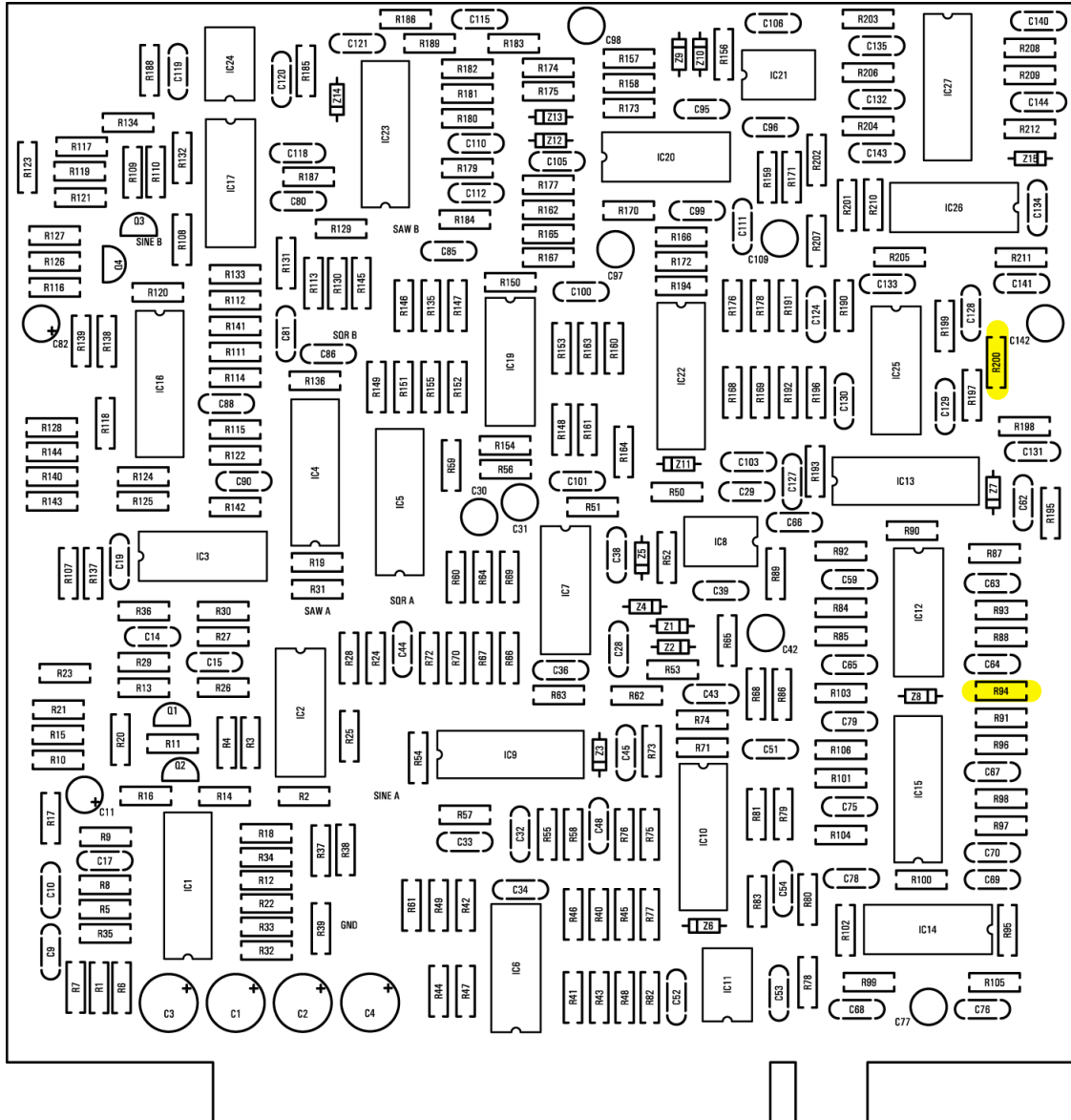

DECKARD'S DREAM

VOICECARD | RESISTOR

12K

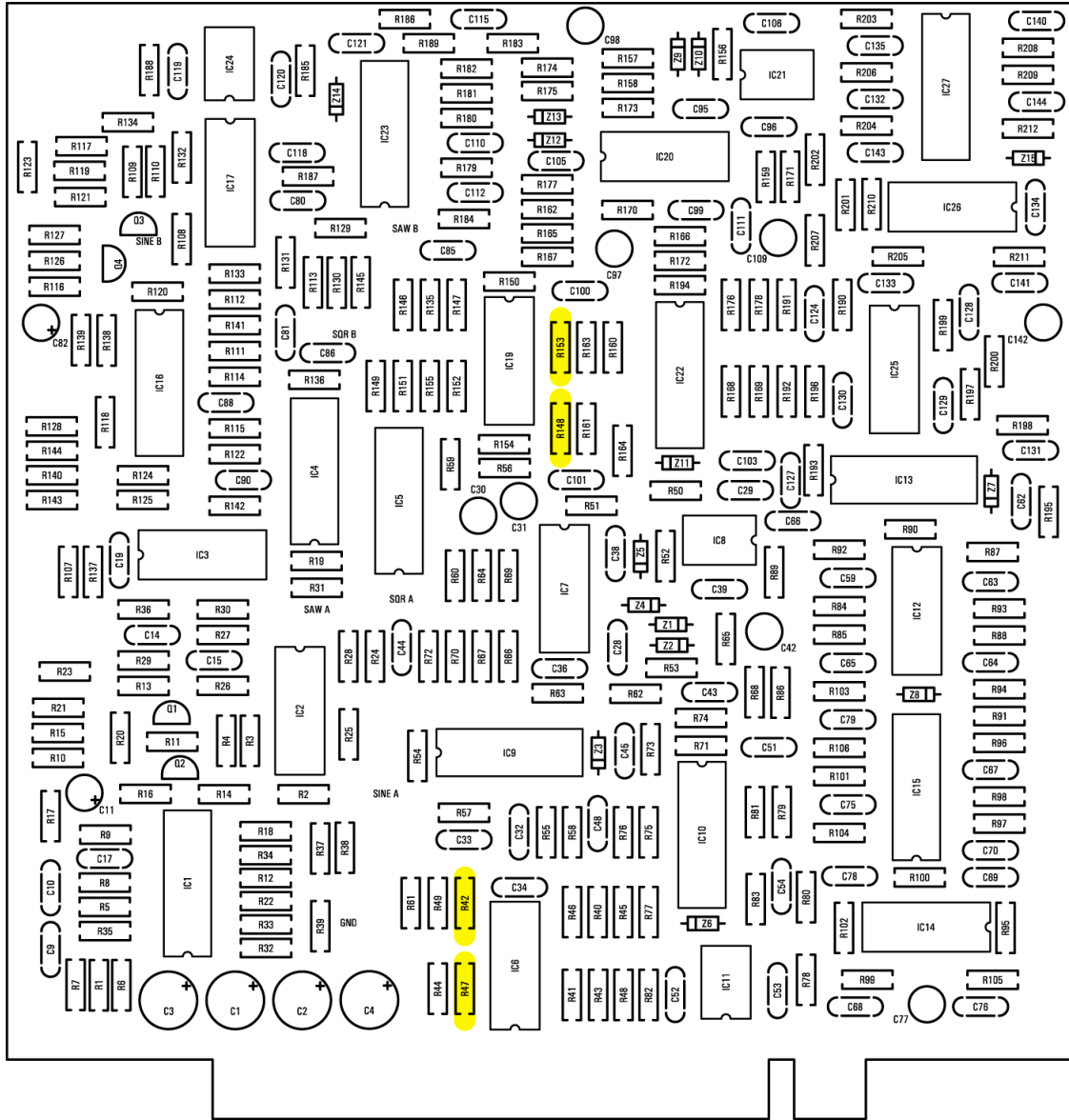

DECKARD'S DREAM

VOICECARD | RESISTOR

10K

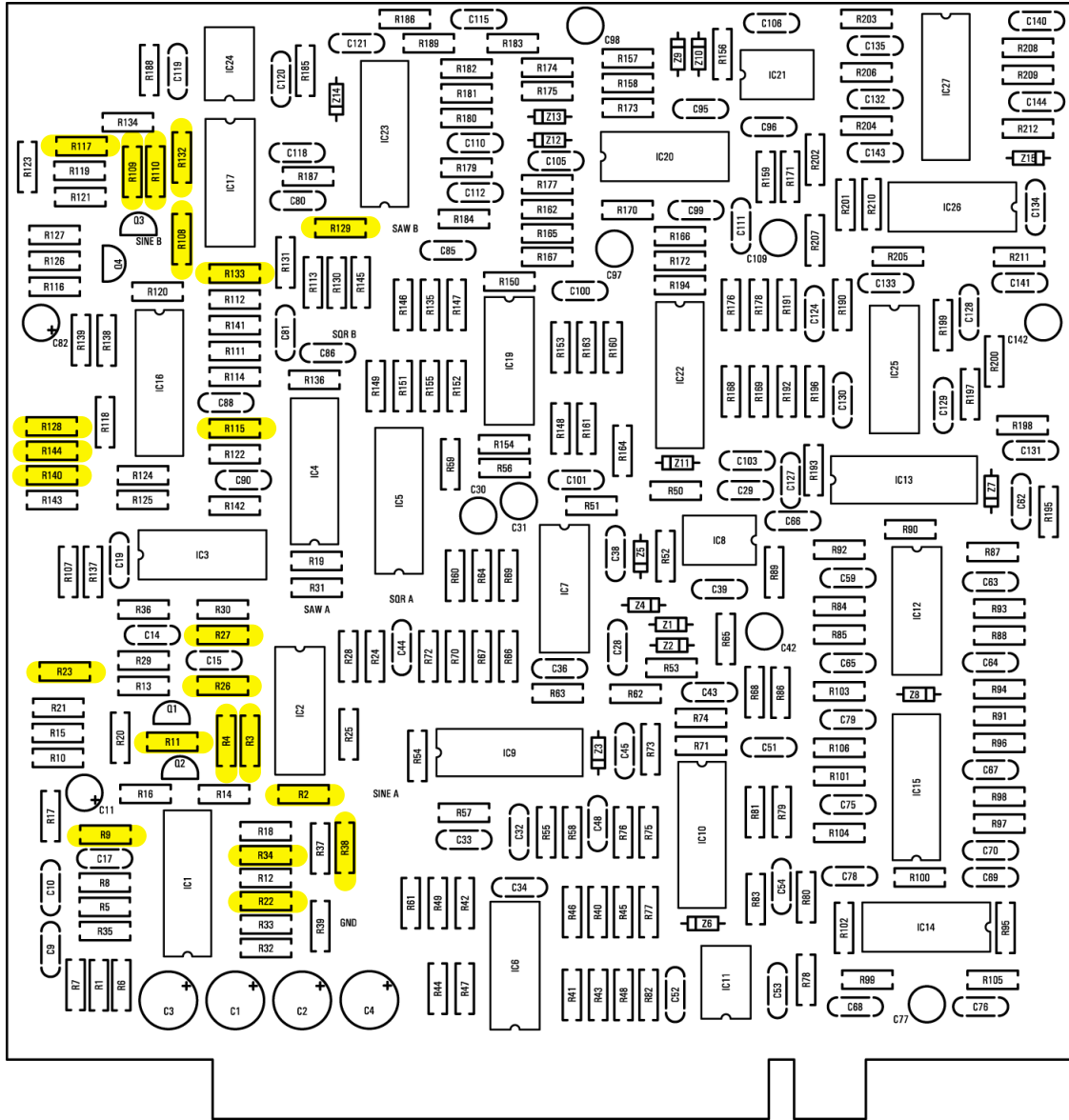

VOICECARD | RESISTOR

8K2

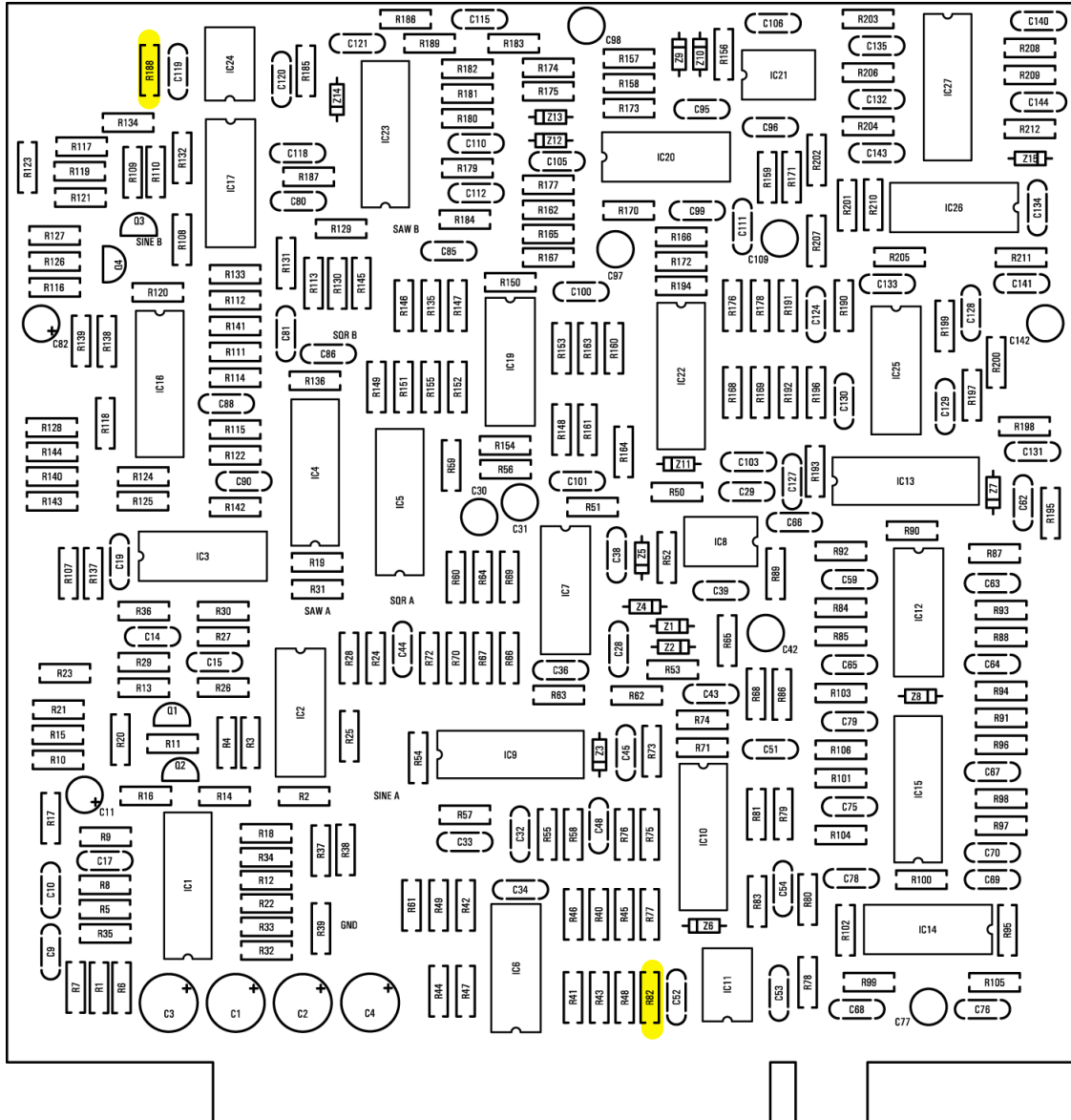

DECKARD'S DREAM

VOICECARD | RESISTOR

5K6

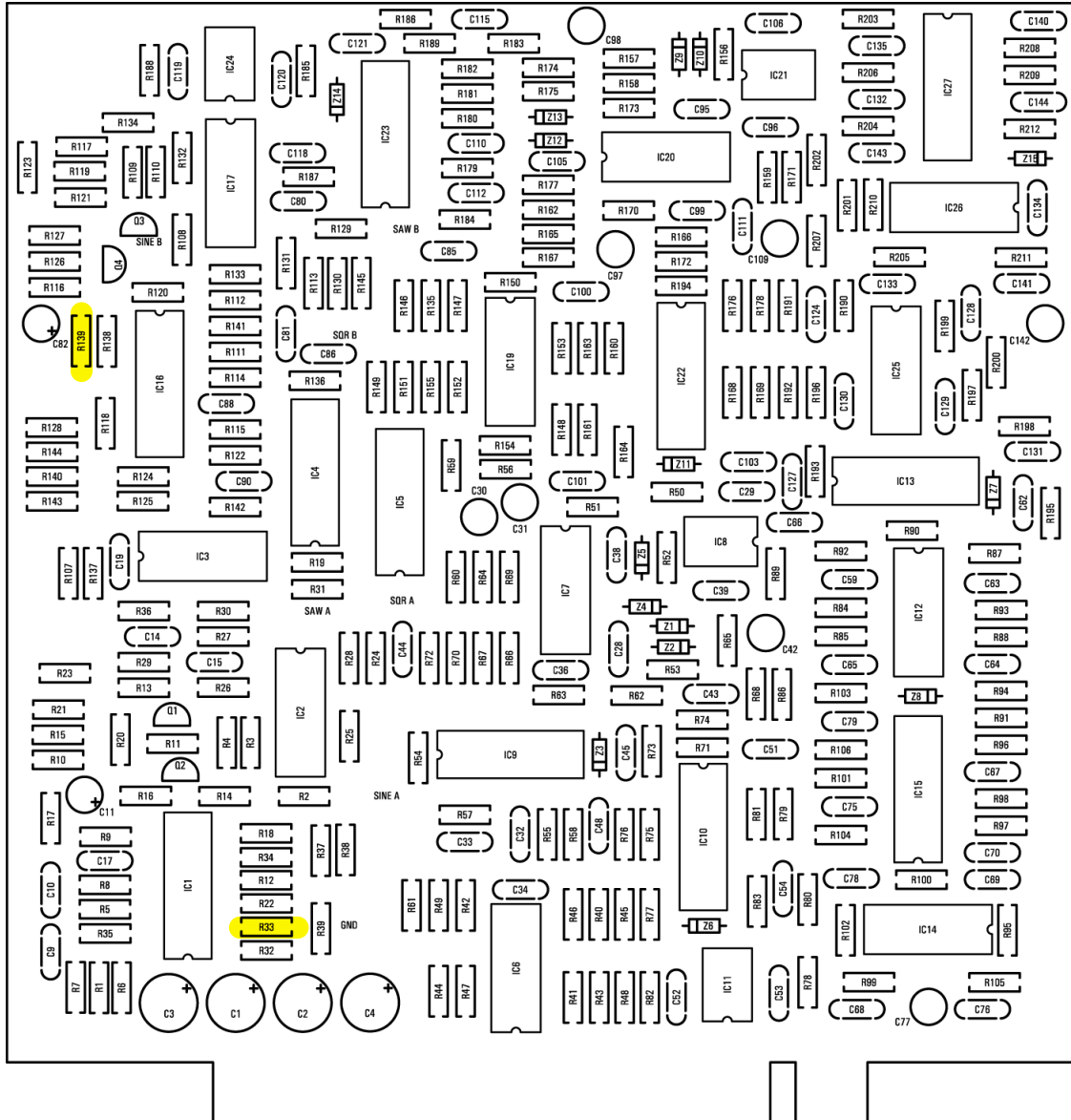

DECKARD'S DREAM

VOICECARD | RESISTOR

4K99

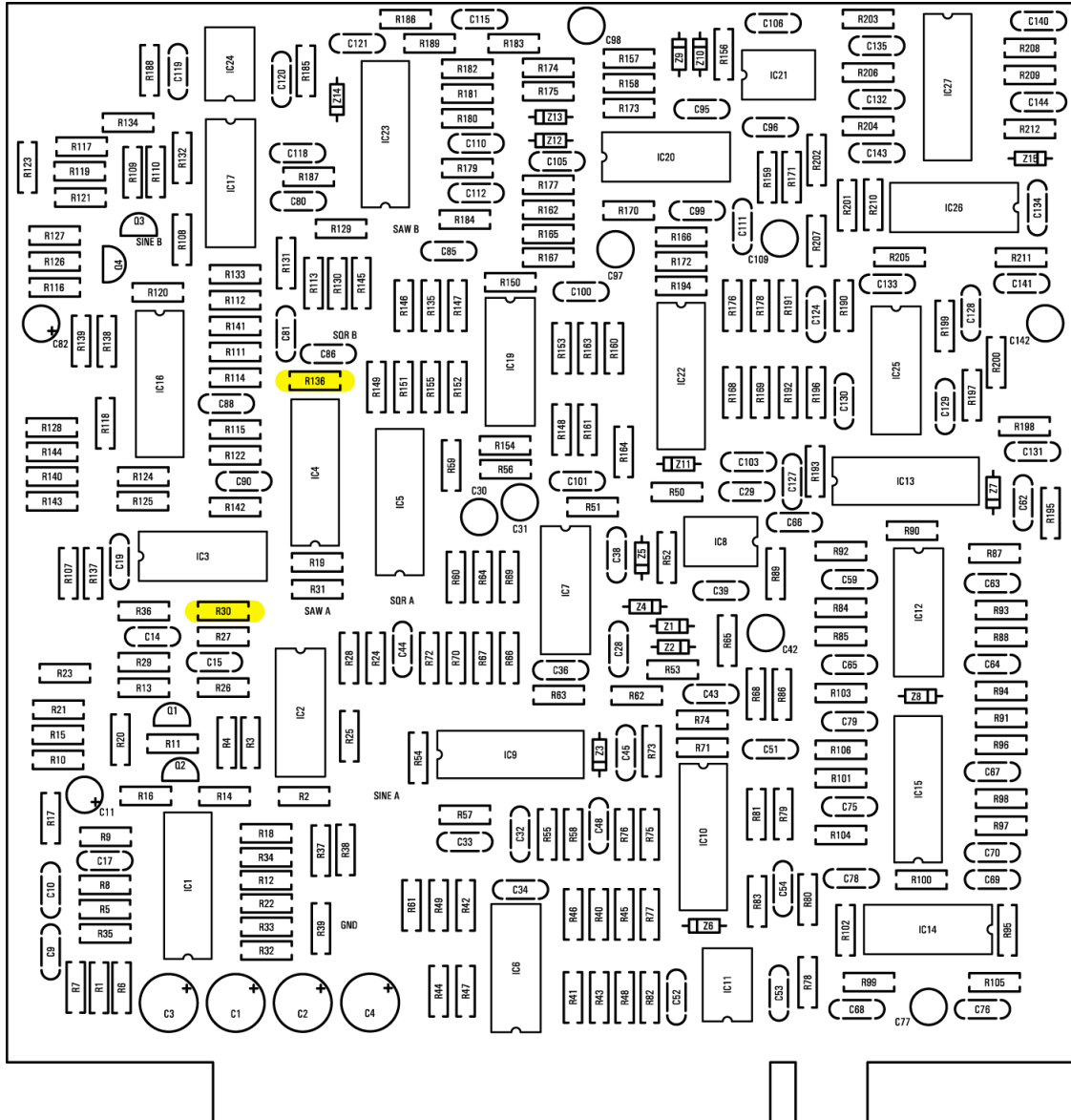

DECKARD'S DREAM

VOICECARD | RESISTOR

3K6

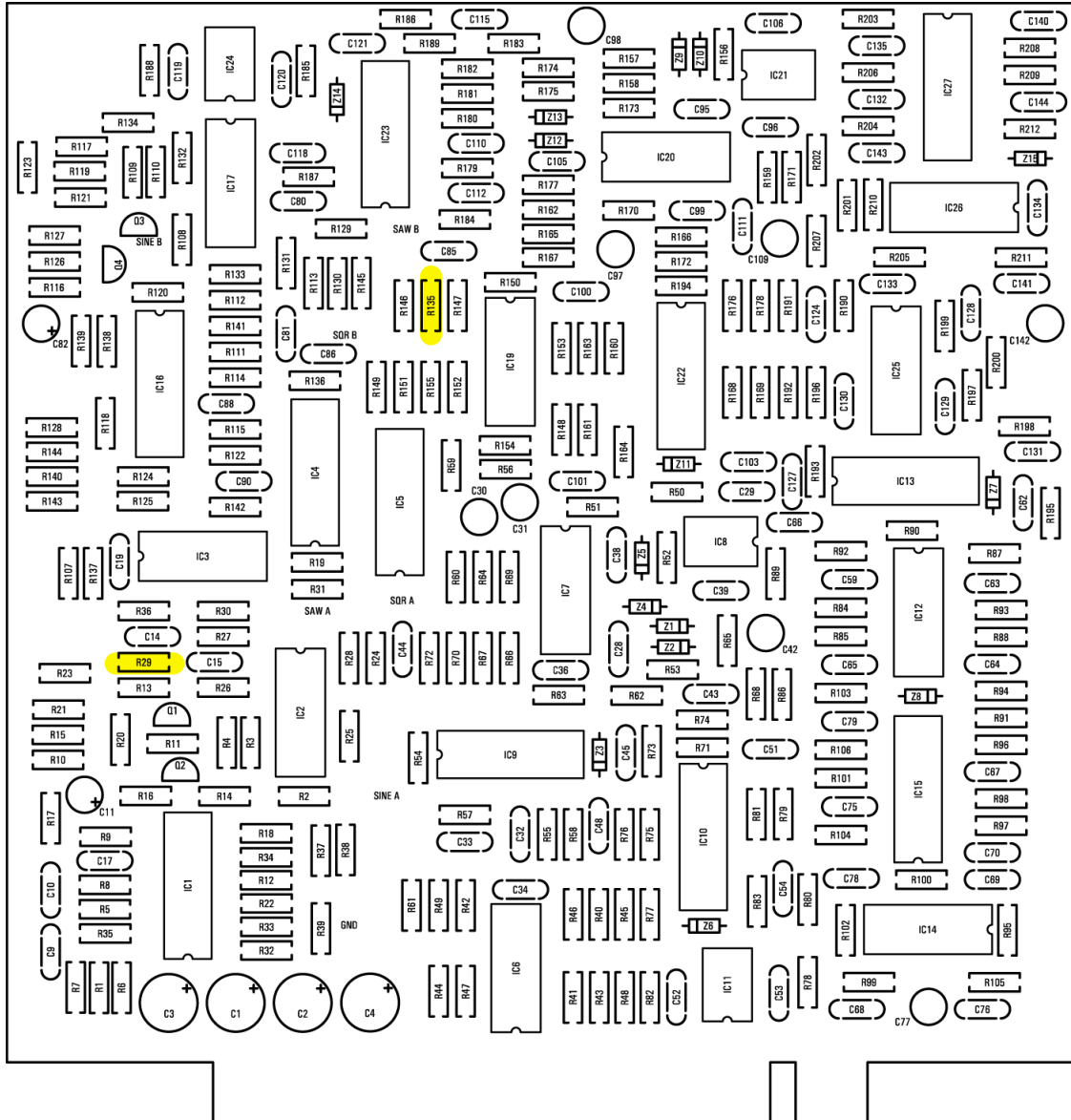

DECKARD'S DREAM

VOICECARD | RESISTOR

2K49

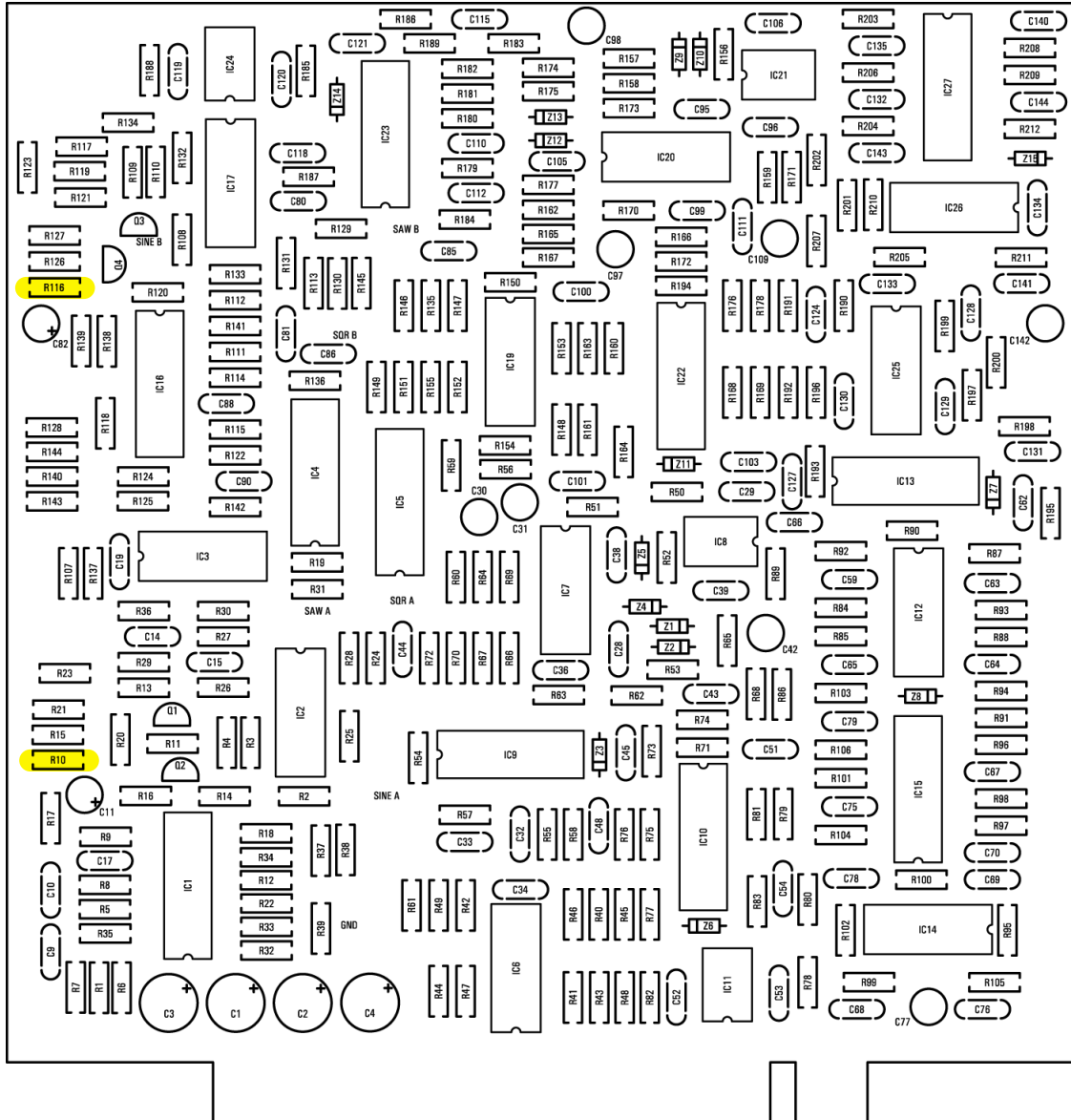

VOICECARD | RESISTOR

2K2

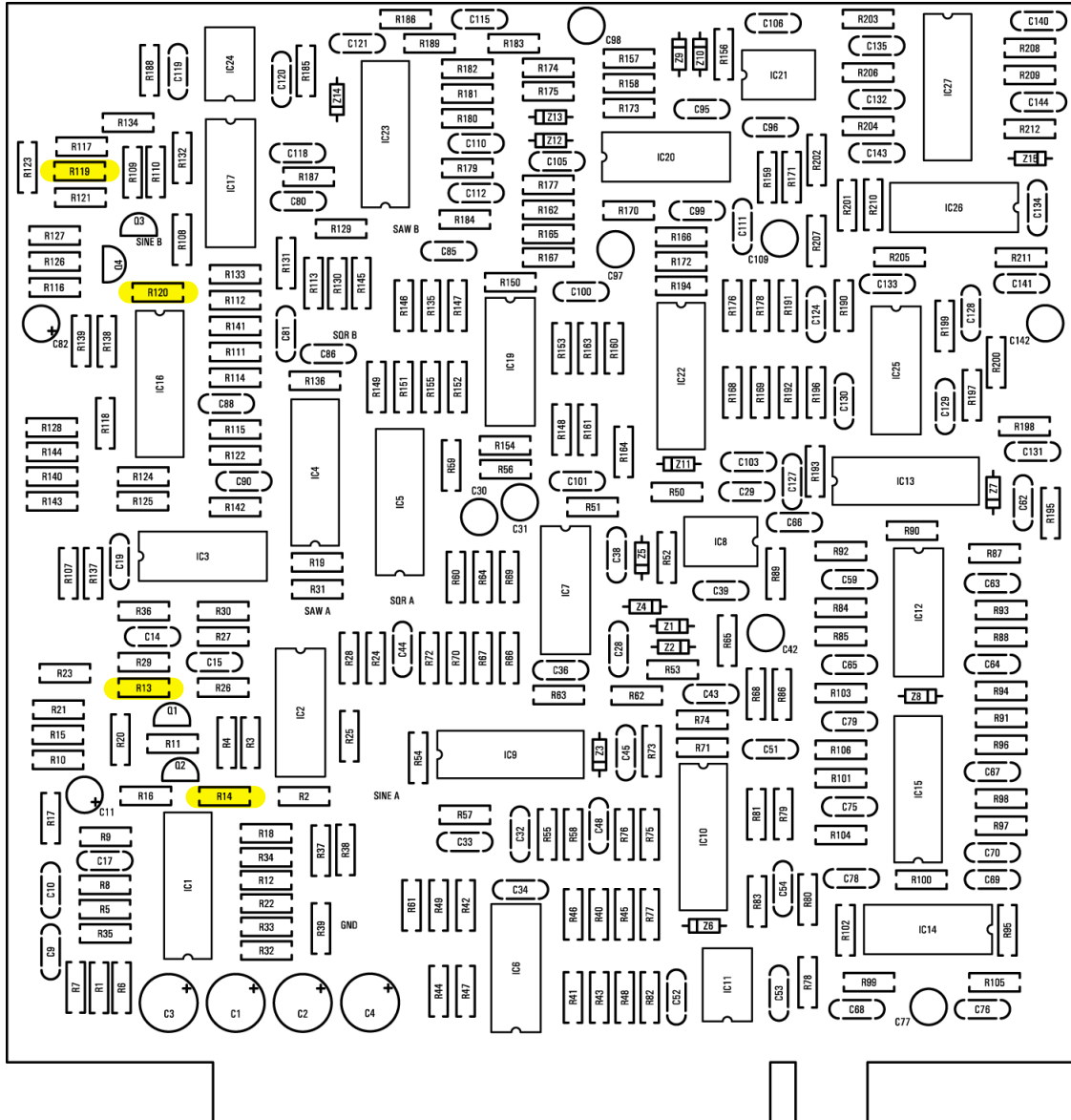

VOICECARD | RESISTOR

2K

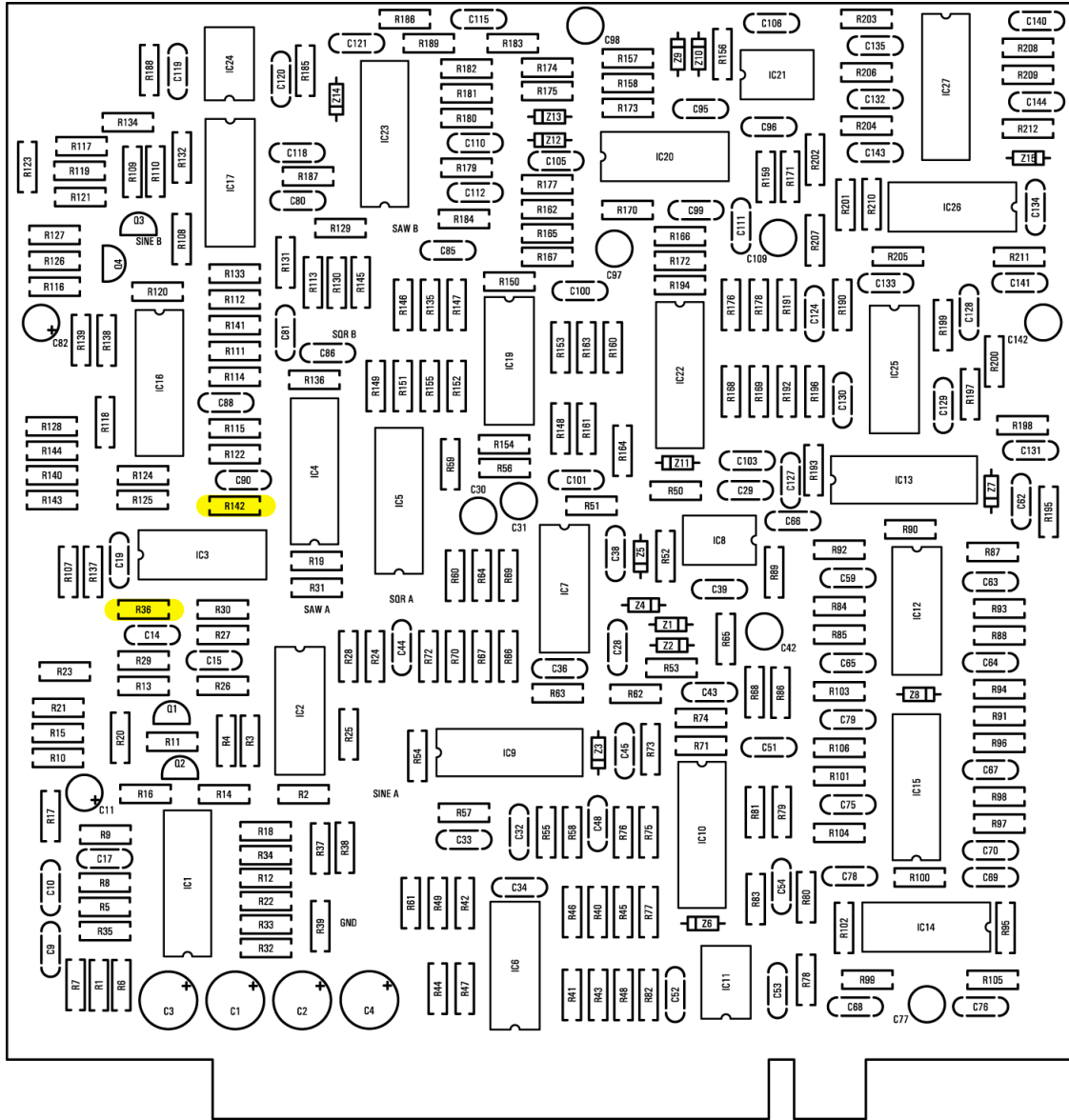

DECKARD'S DREAM

VOICECARD | RESISTOR

1K8

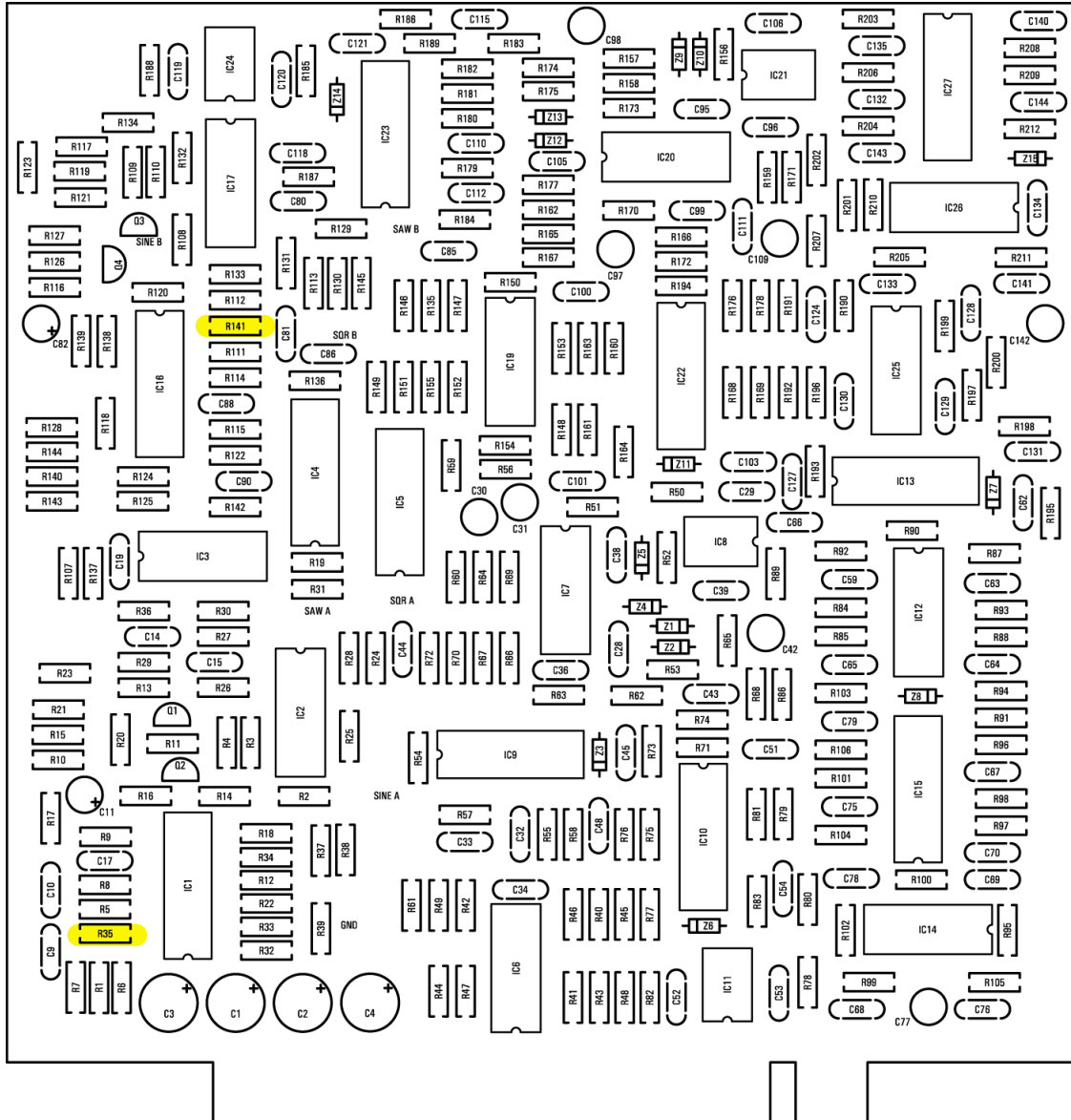

DECKARD'S DREAM

VOICECARD | RESISTOR

1K

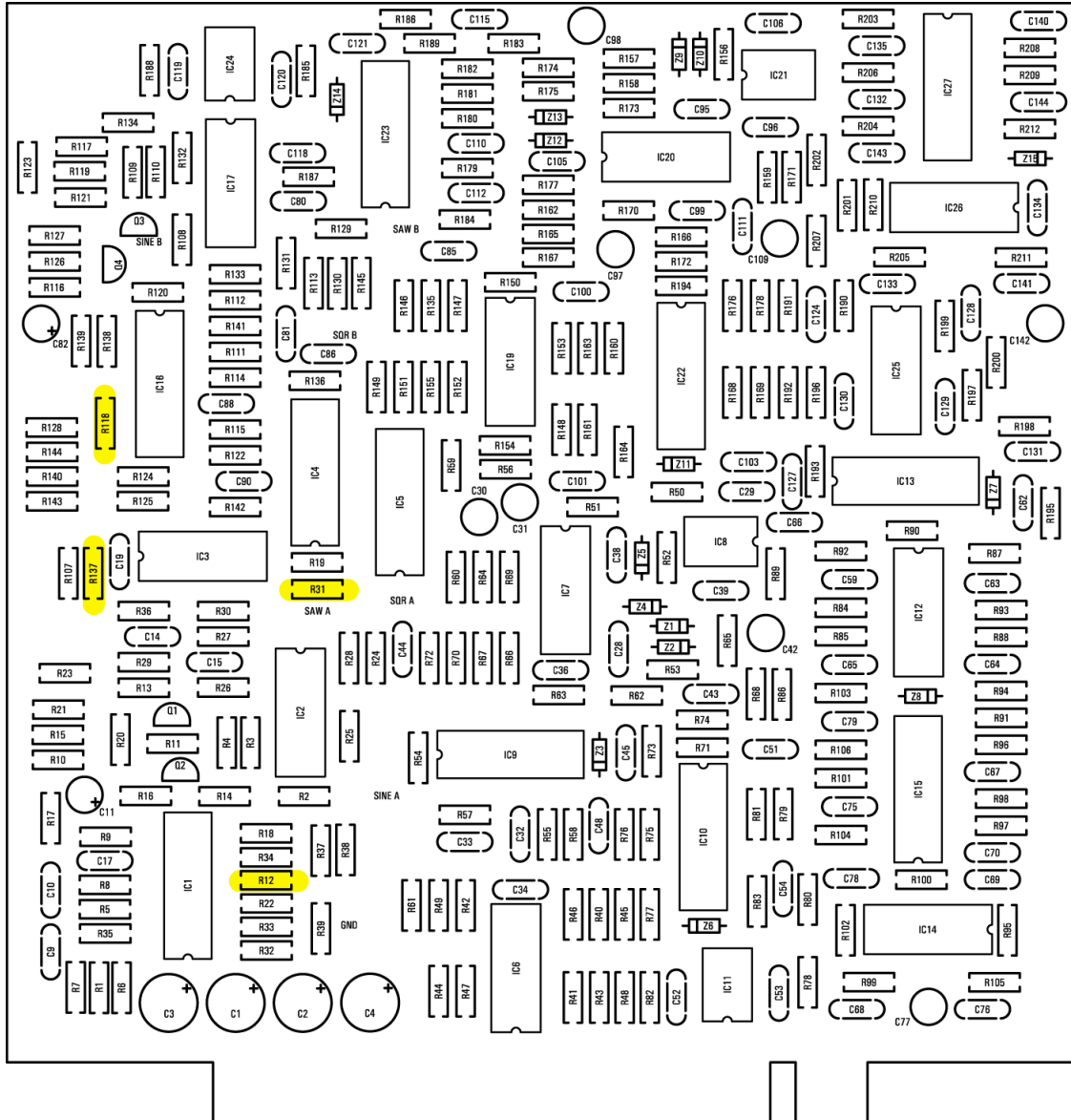

DECKARD'S DREAM

VOICECARD | RESISTOR

870R

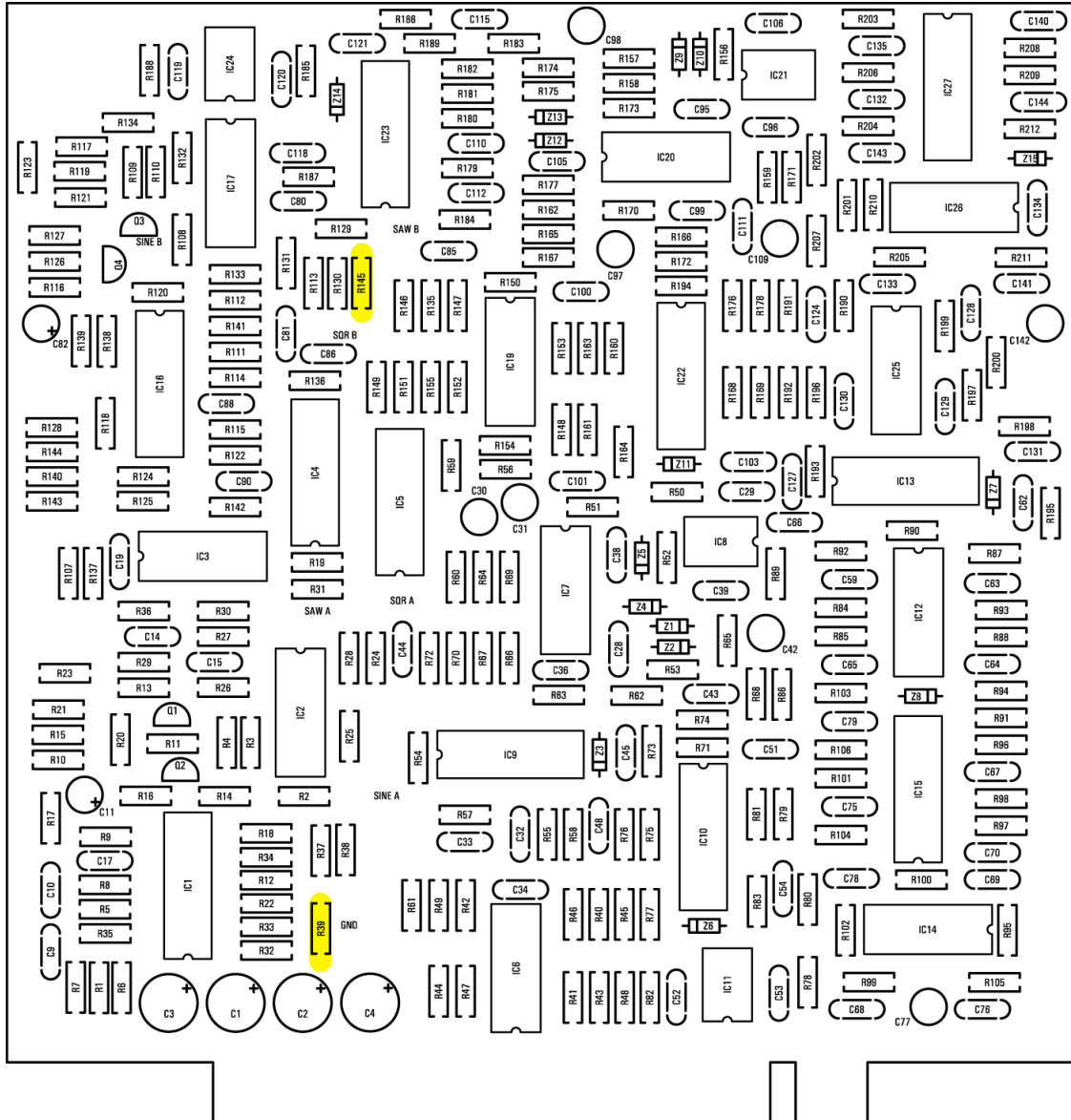

VOICECARD | RESISTOR

499R

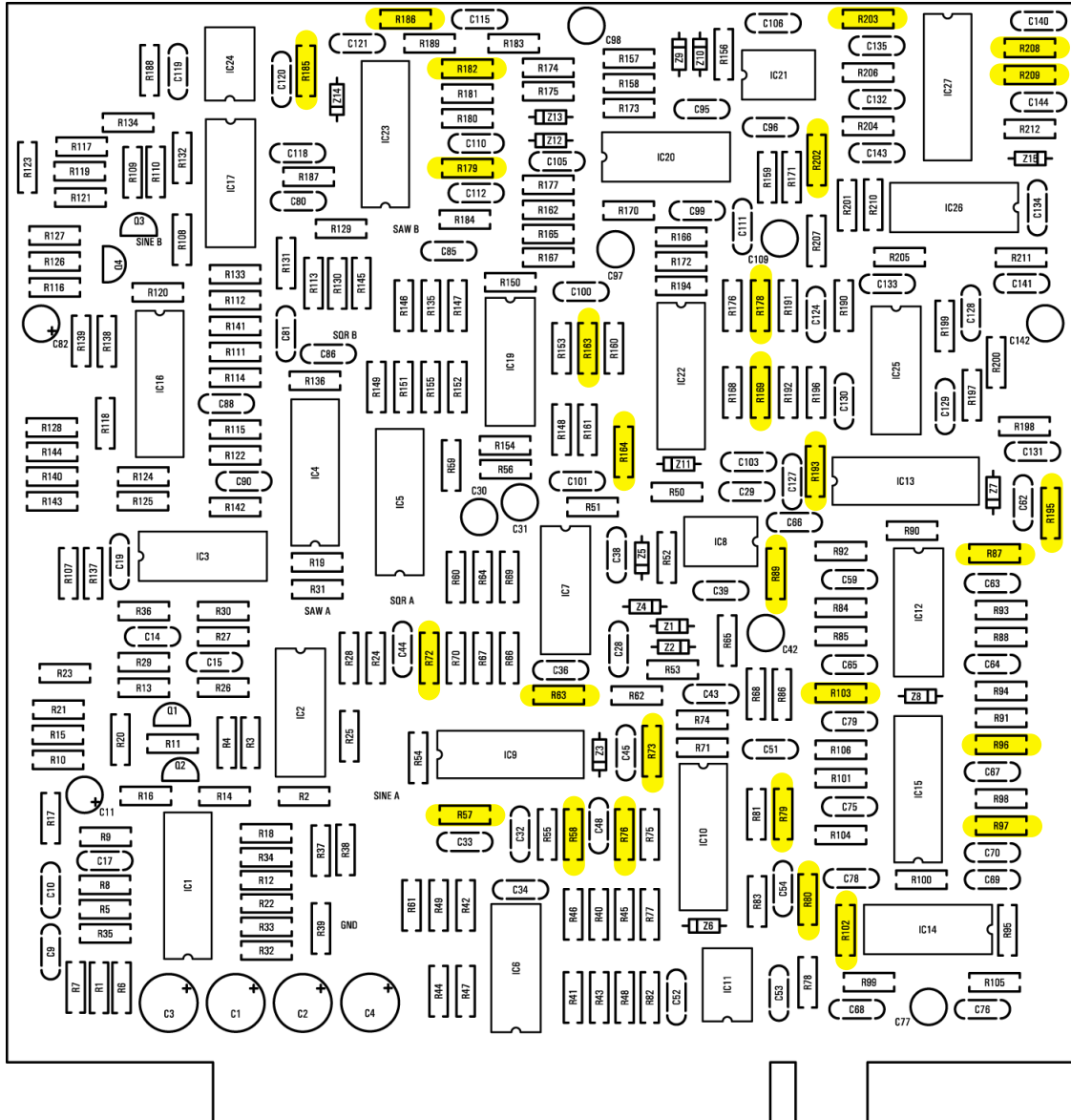

VOICECARD | RESISTOR

470R

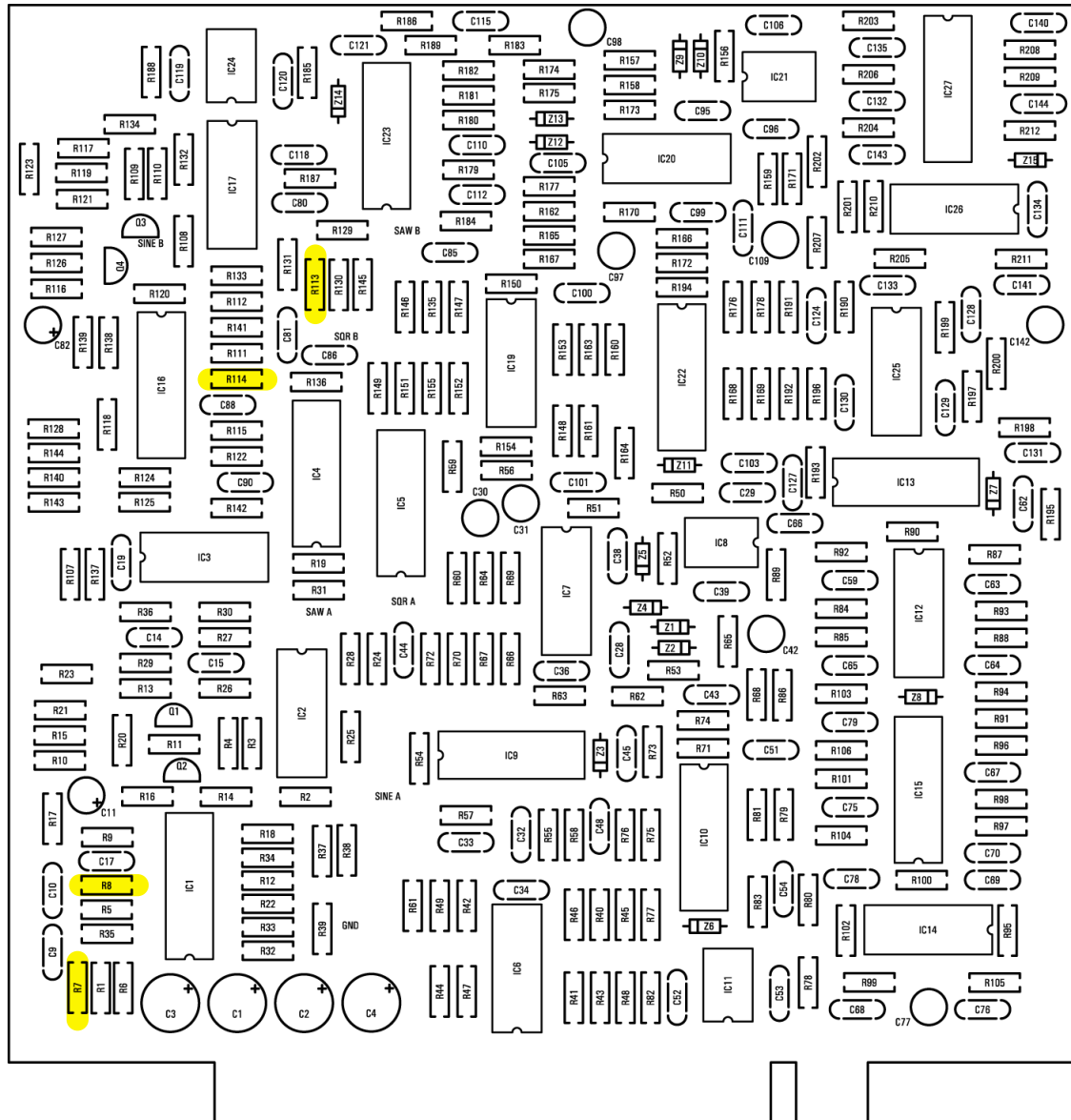

DECKARD'S DREAM

VOICECARD | RESISTOR

309R

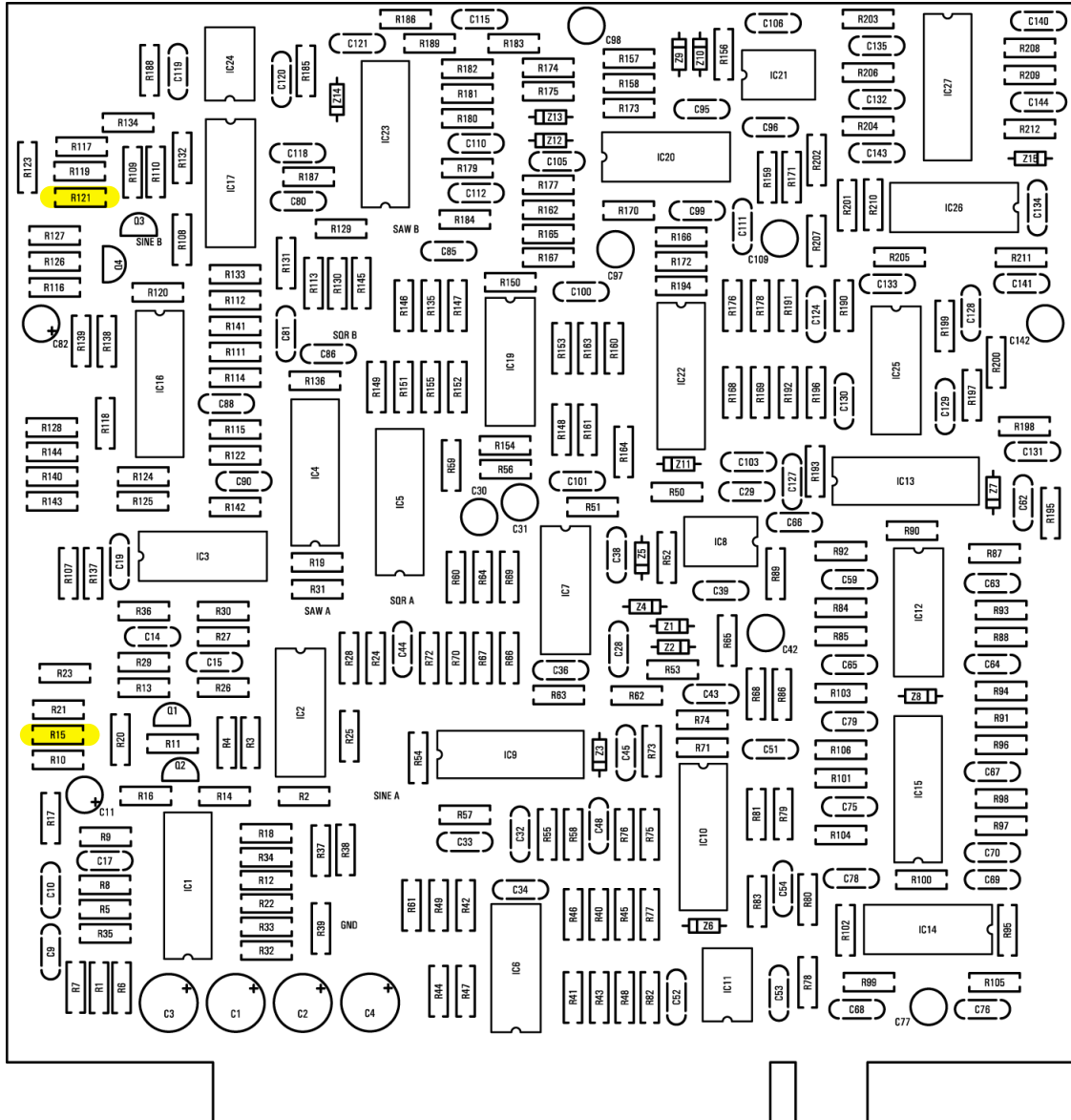

VOICECARD | RESISTOR LEAVE EMPTY

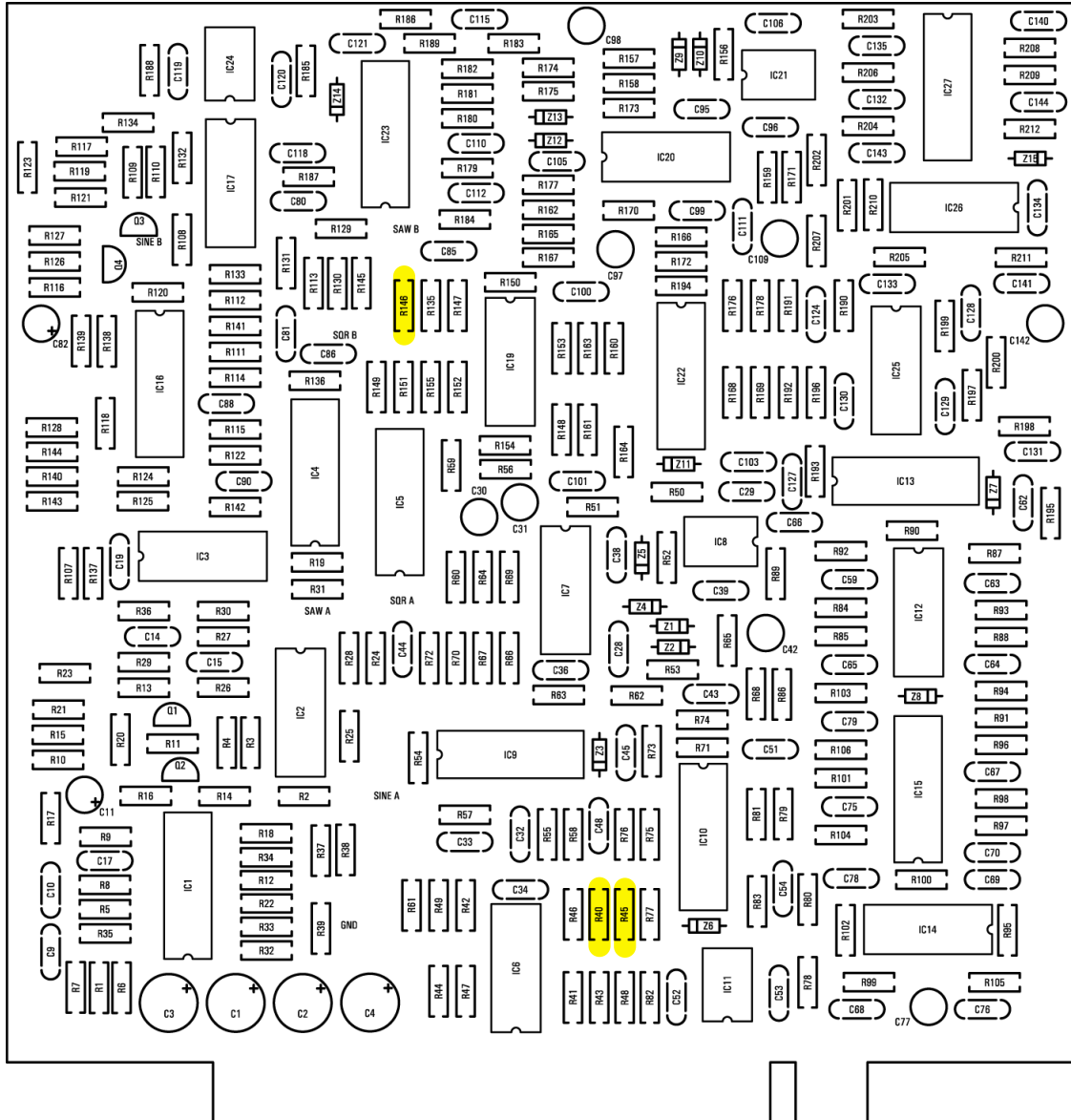

DECKARD'S DREAM

VOICECARD | CAPACITOR

220uF

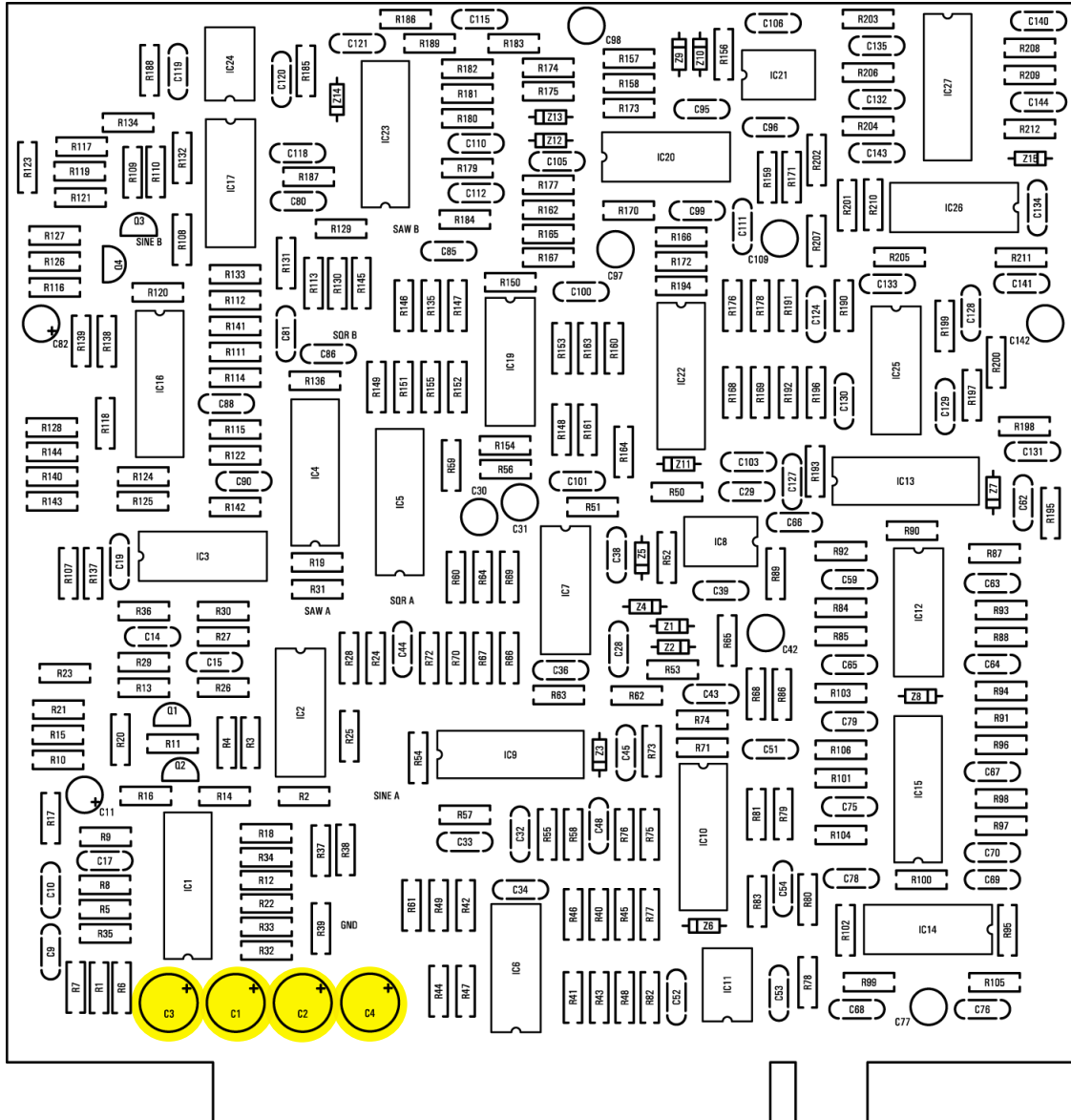

DECKARD'S DREAM

VOICECARD | CAPACITOR

47uF

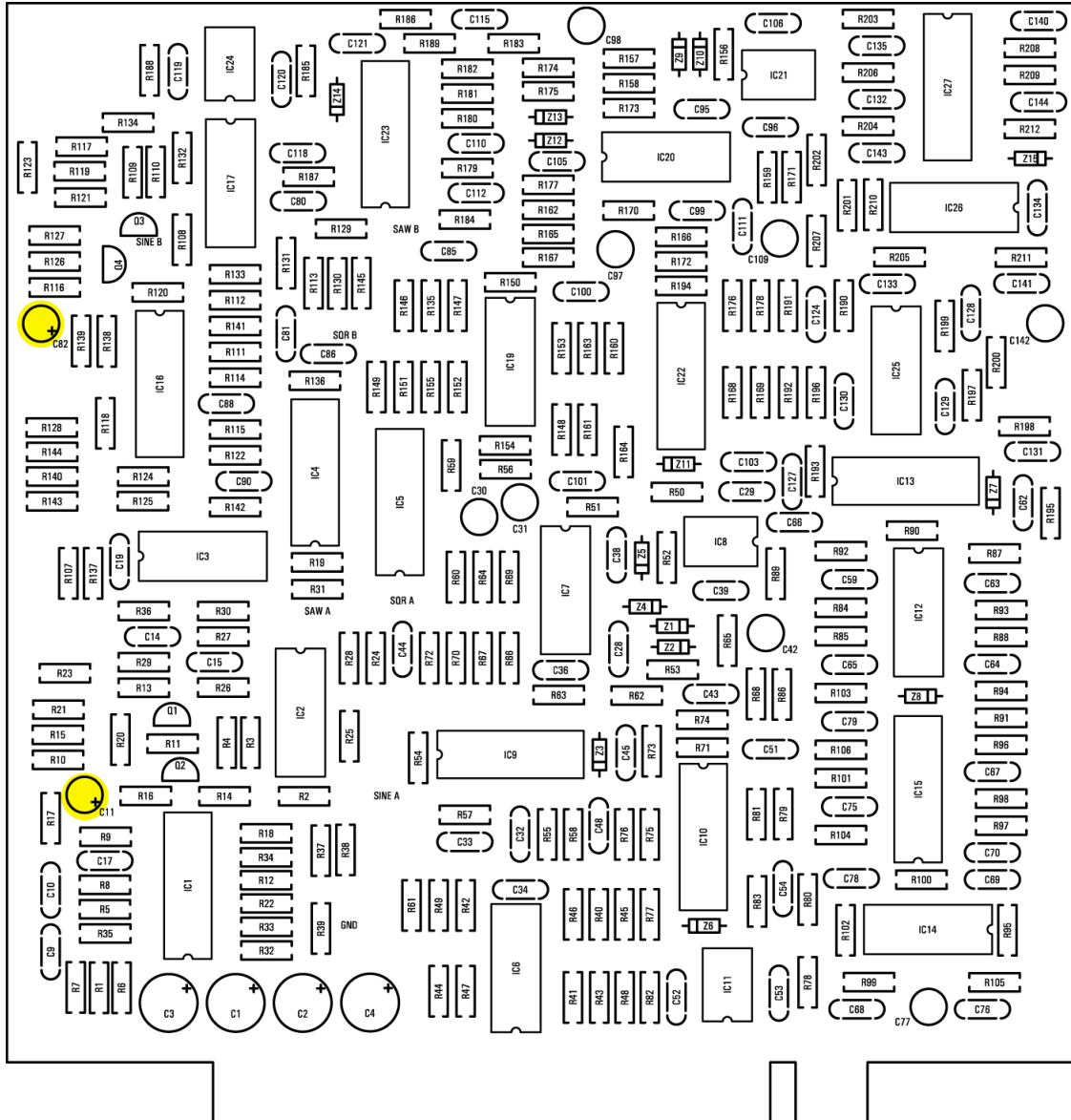

DECKARD'S DREAM

VOICECARD | CAPACITOR

1uF

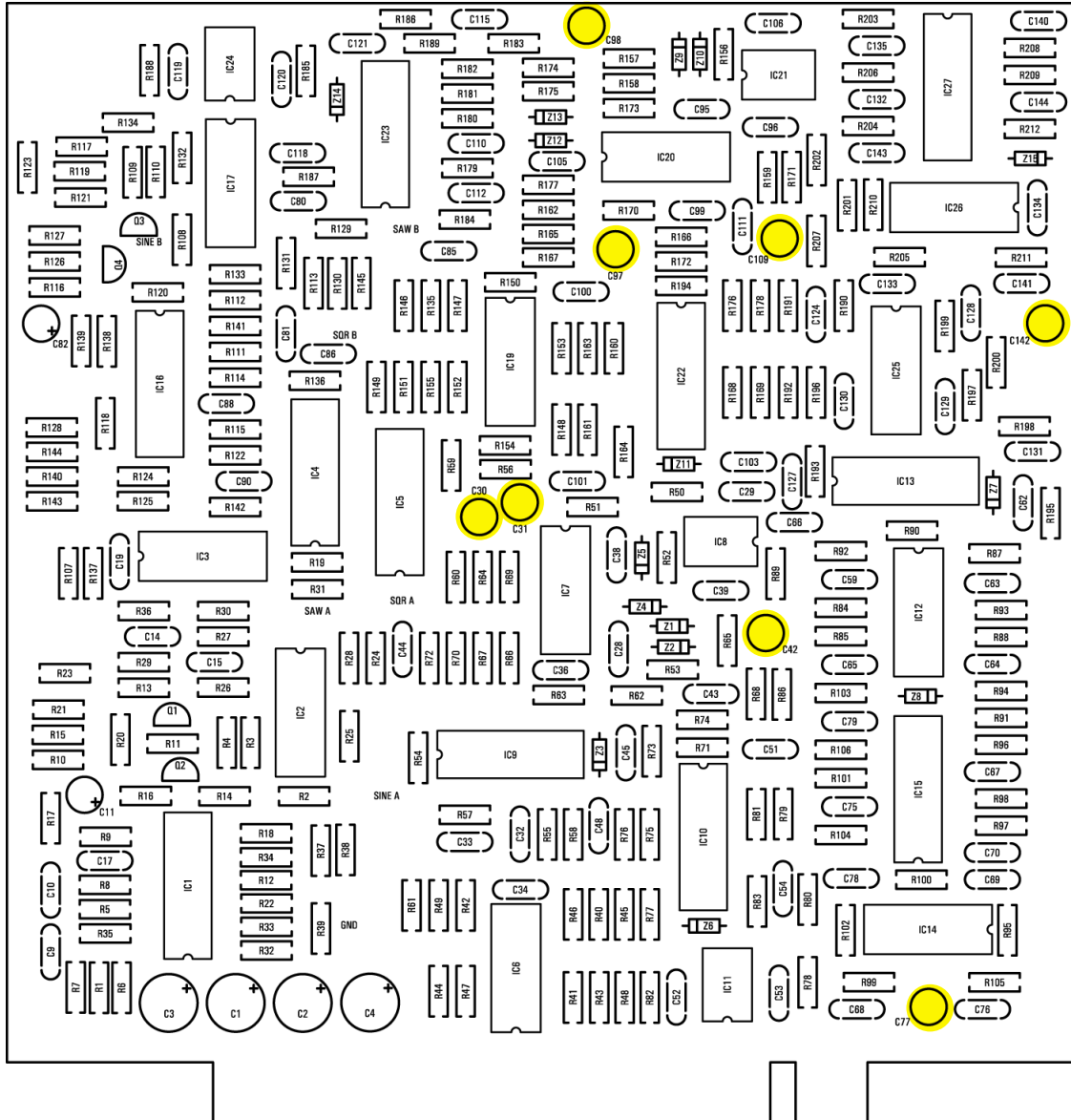

DECKARD'S DREAM

VOICECARD | CAPACITOR

0.01uF

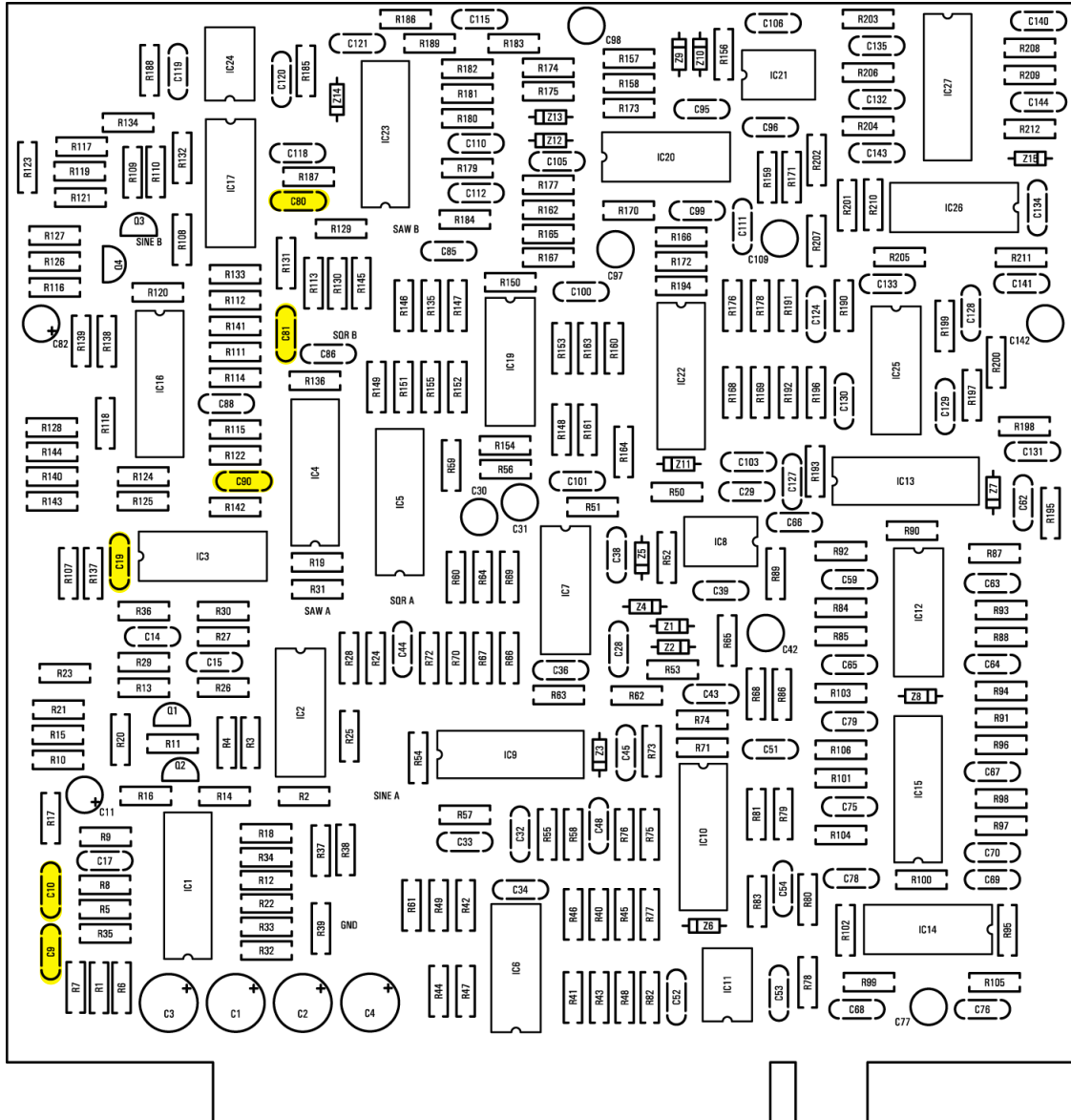

DECKARD'S DREAM

VOICECARD | CAPACITOR

1000pF

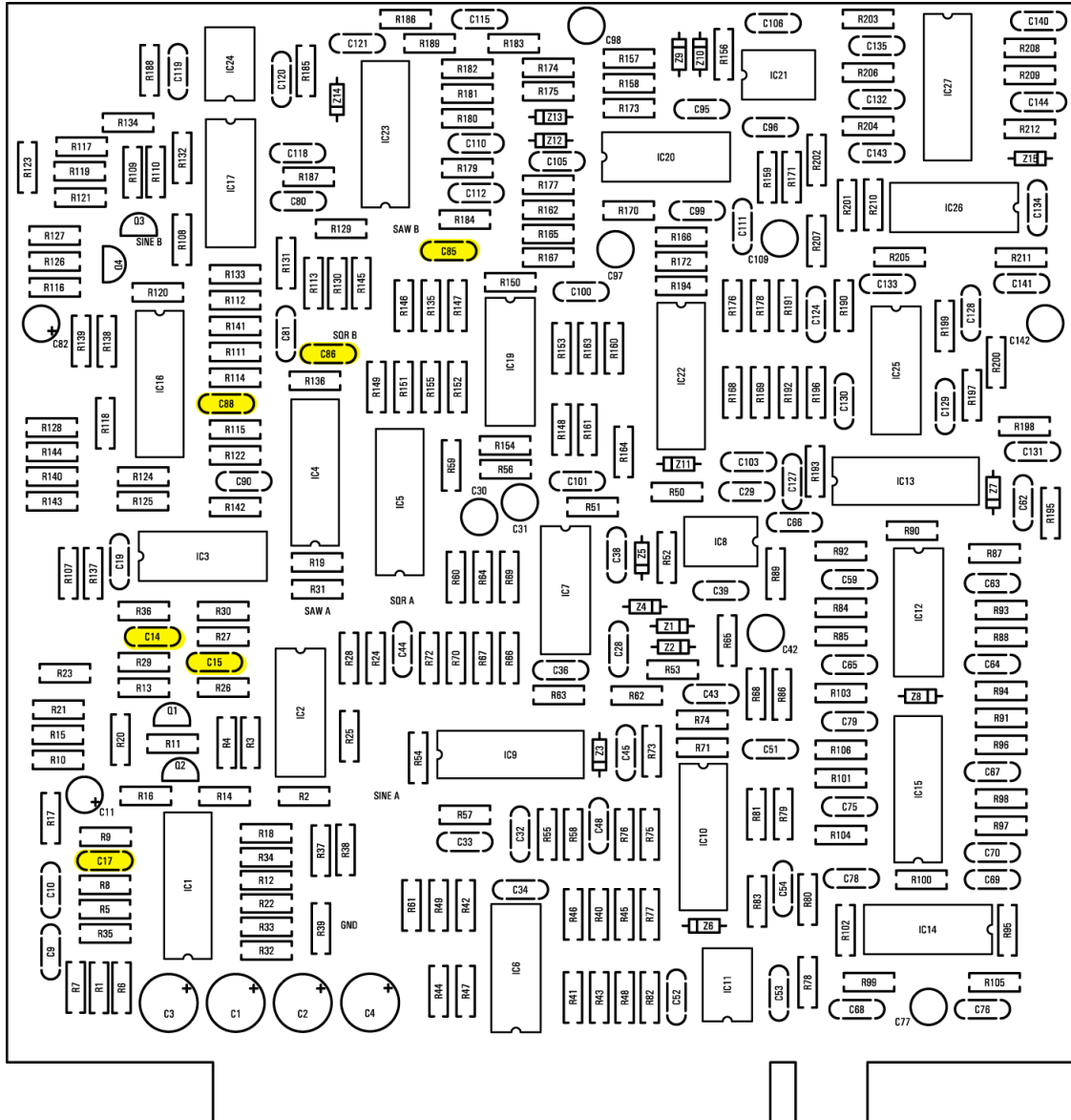

DECKARD'S DREAM

VOICECARD | CAPACITOR

560pF

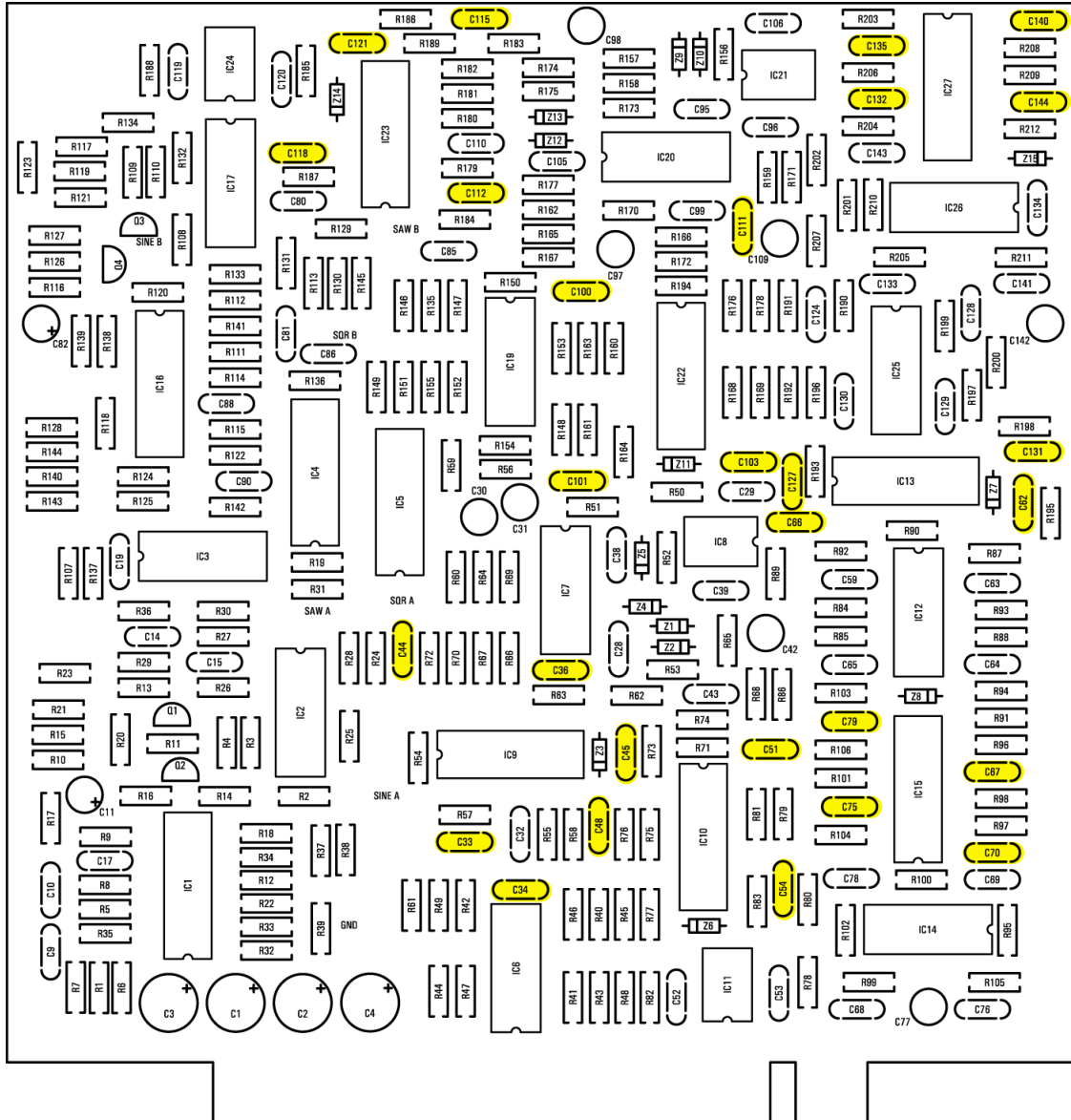

DECKARD'S DREAM

VOICECARD | CAPACITOR

180pF

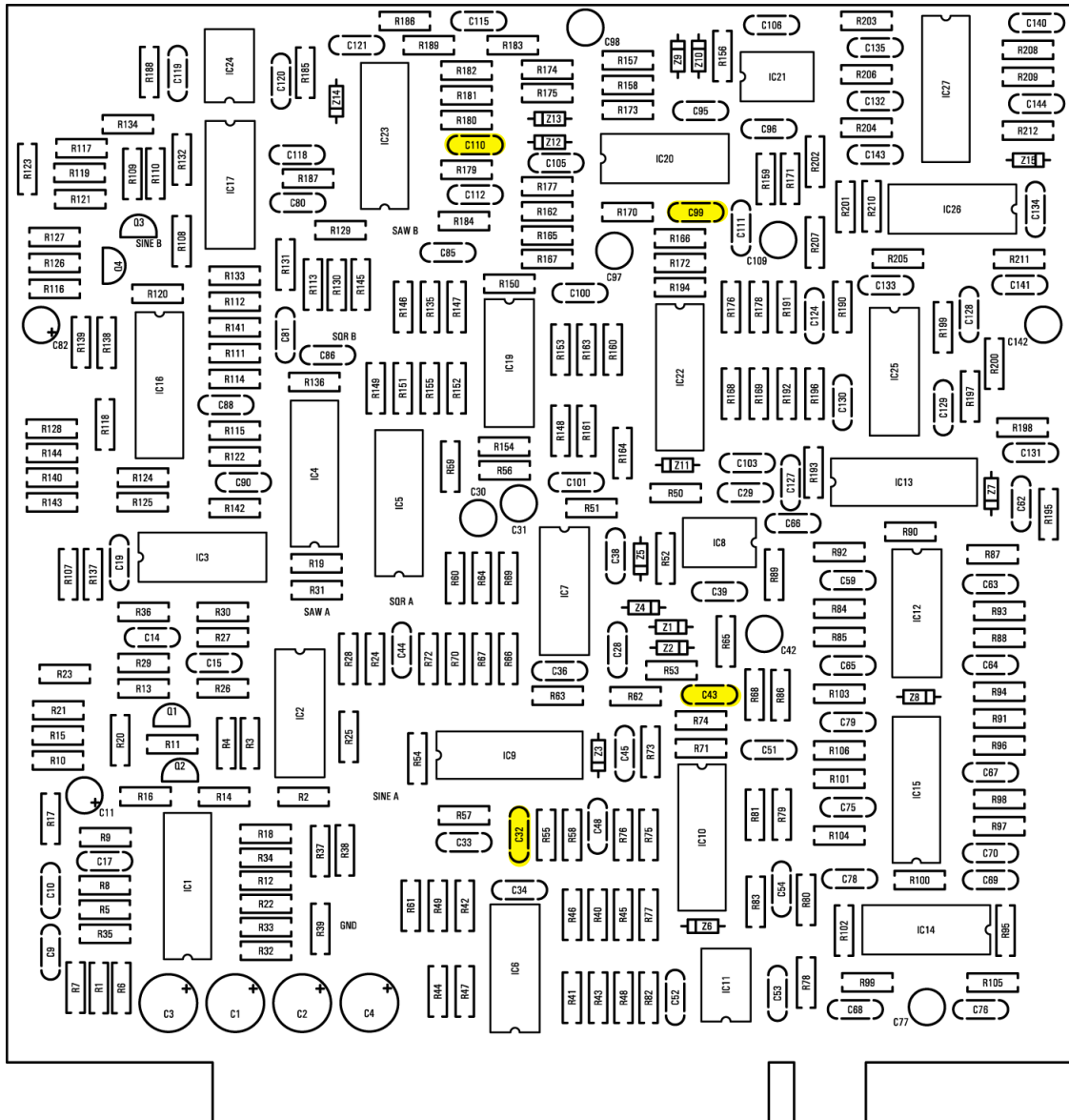

DECKARD'S DREAM

VOICECARD | CAPACITOR

100pF

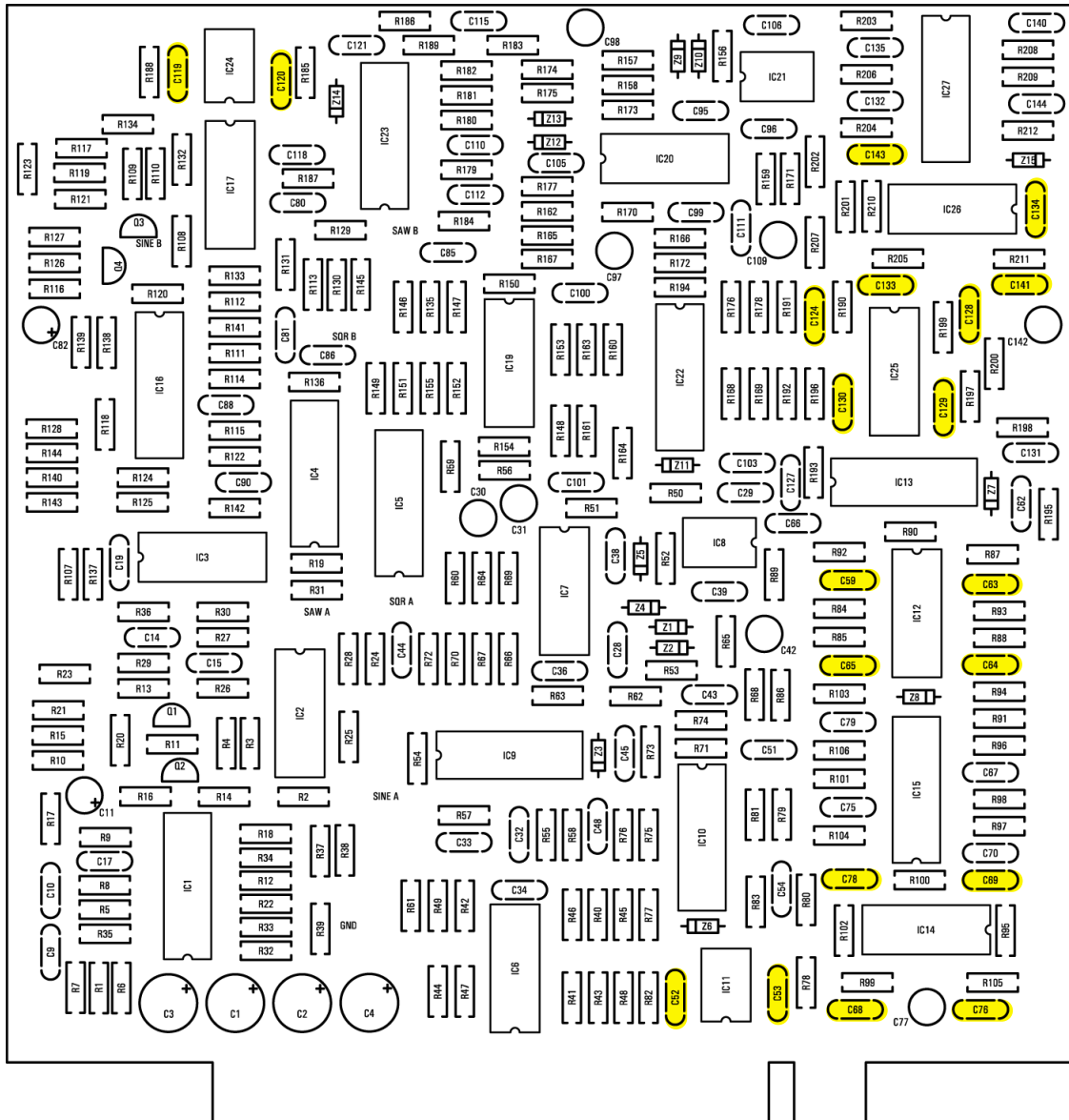

DECKARD'S DREAM

VOICECARD | CAPACITOR

1.5nF

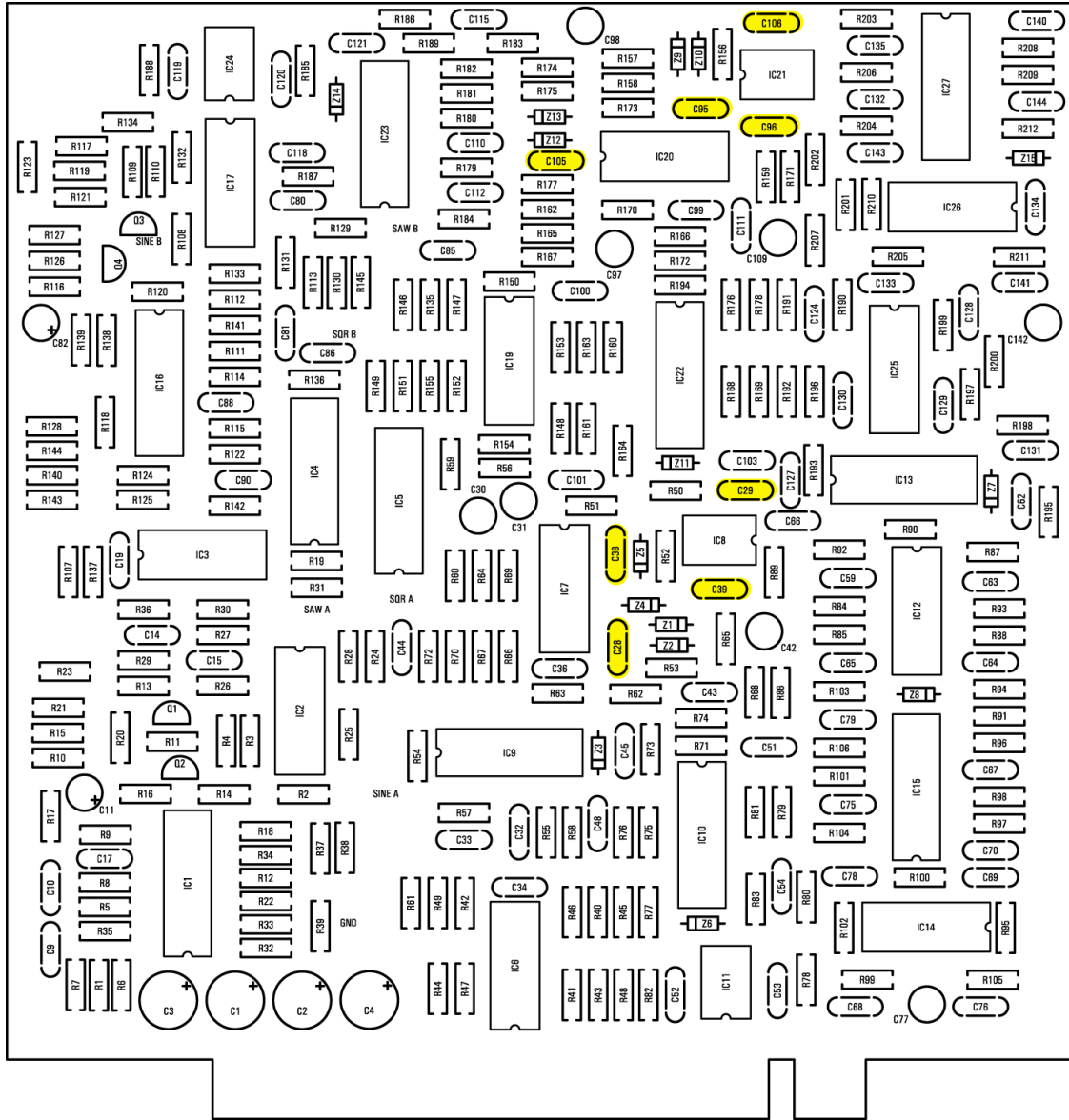

DECKARD'S DREAM

VOICECARD | TRANSISTOR

2N3904

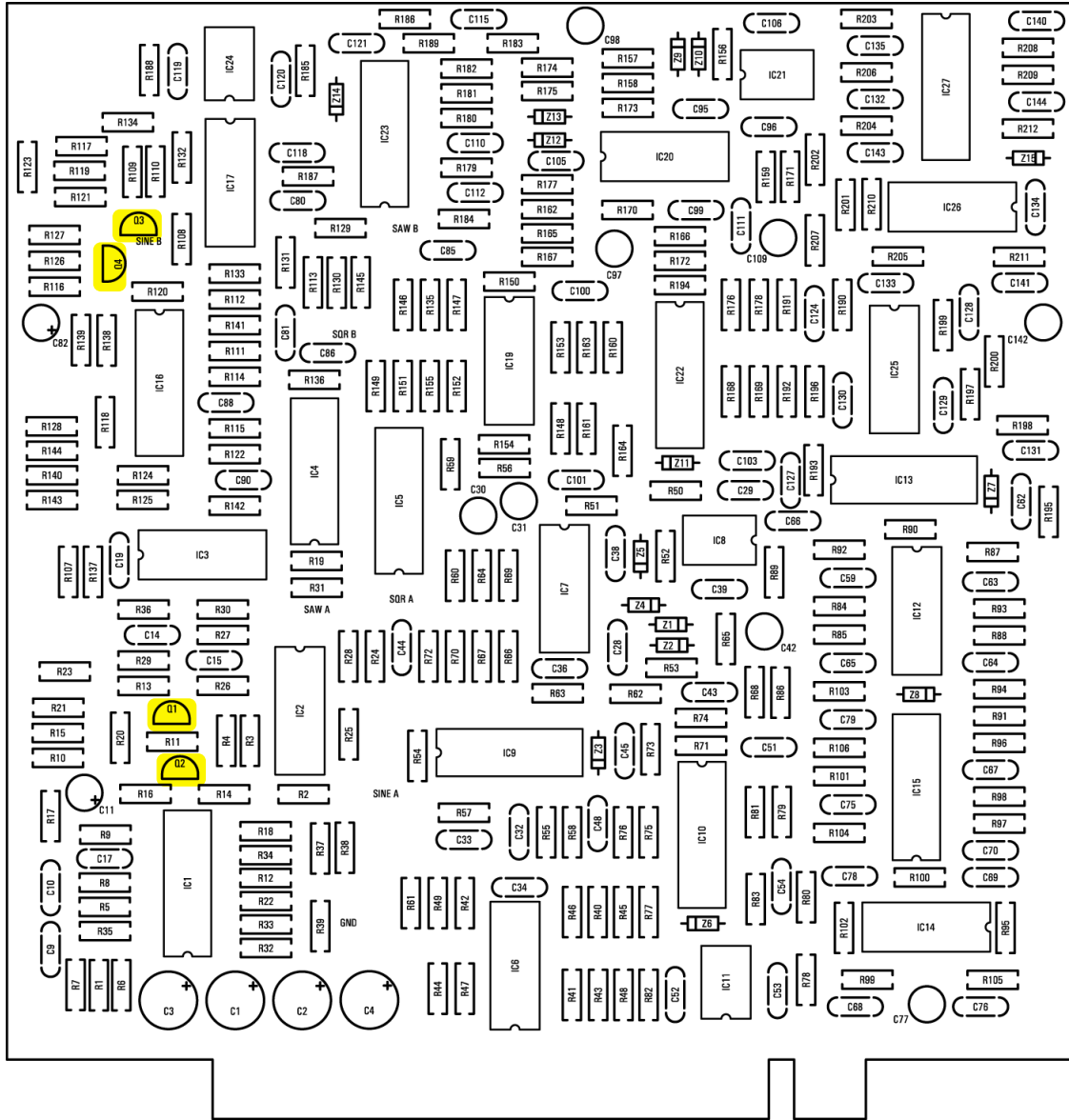

VOICECARD | IC

CEM3340

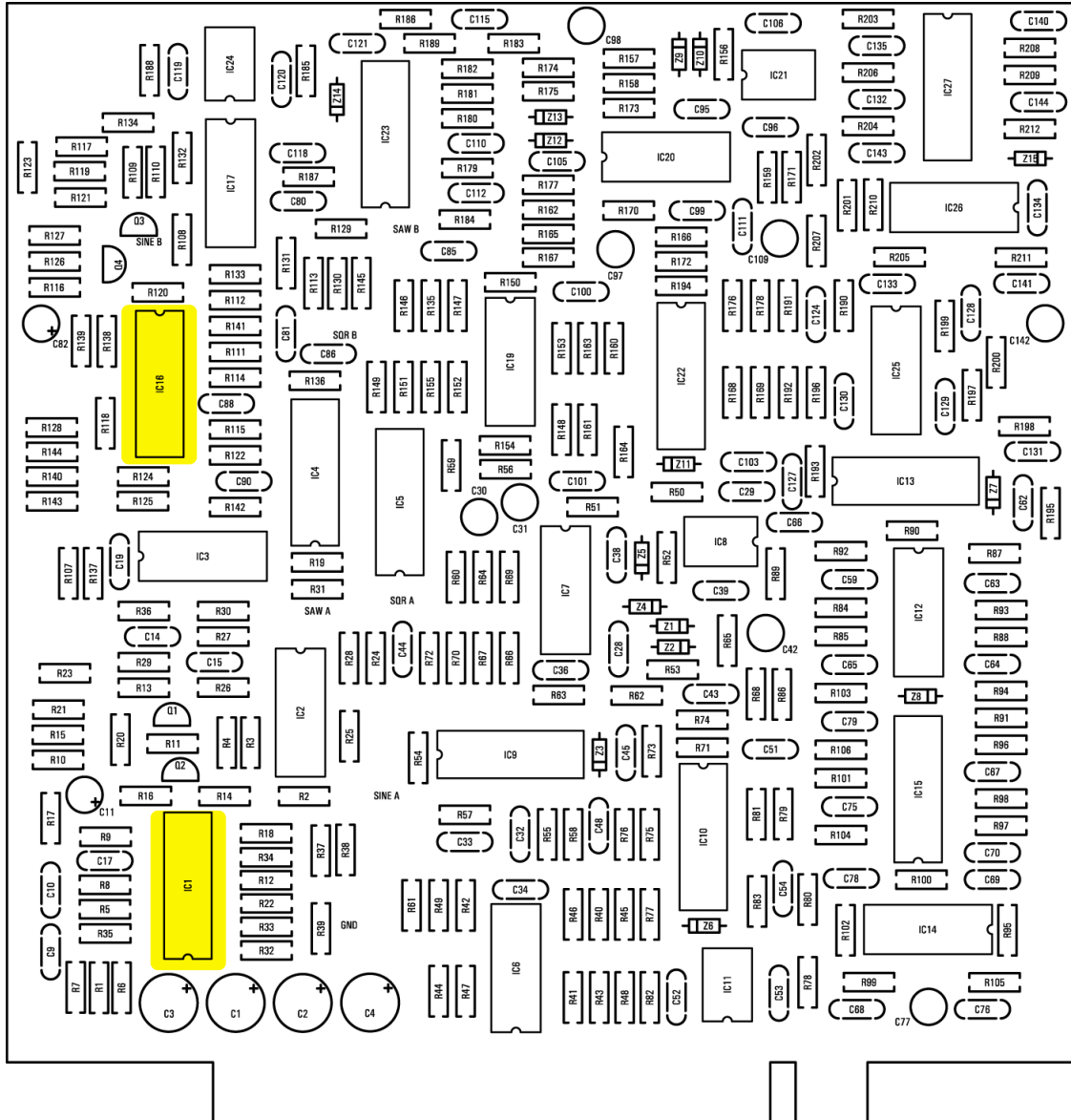

DECKARD'S DREAM

VOICECARD | IC

TL074

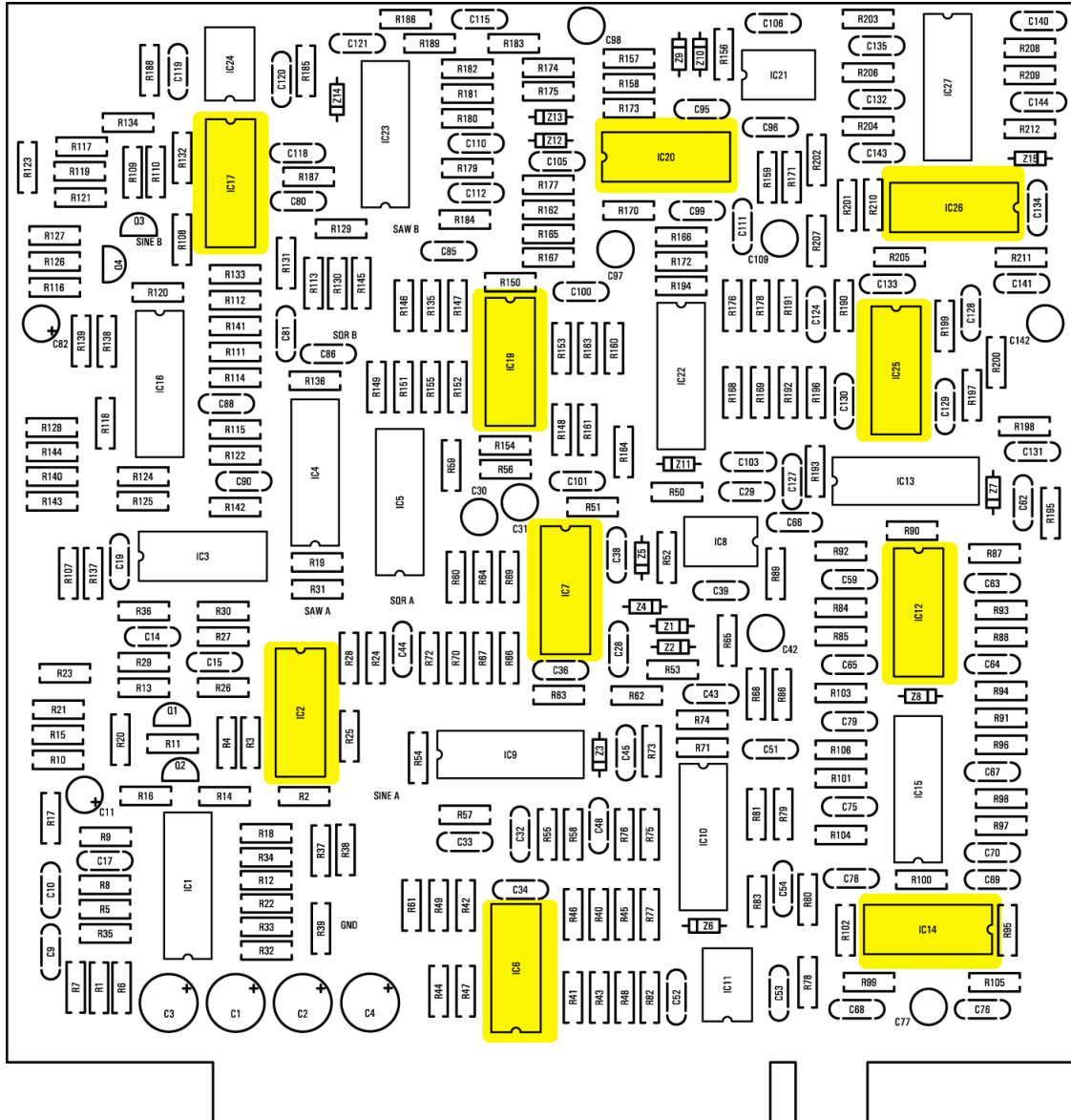

VOICECARD | IC

TL072

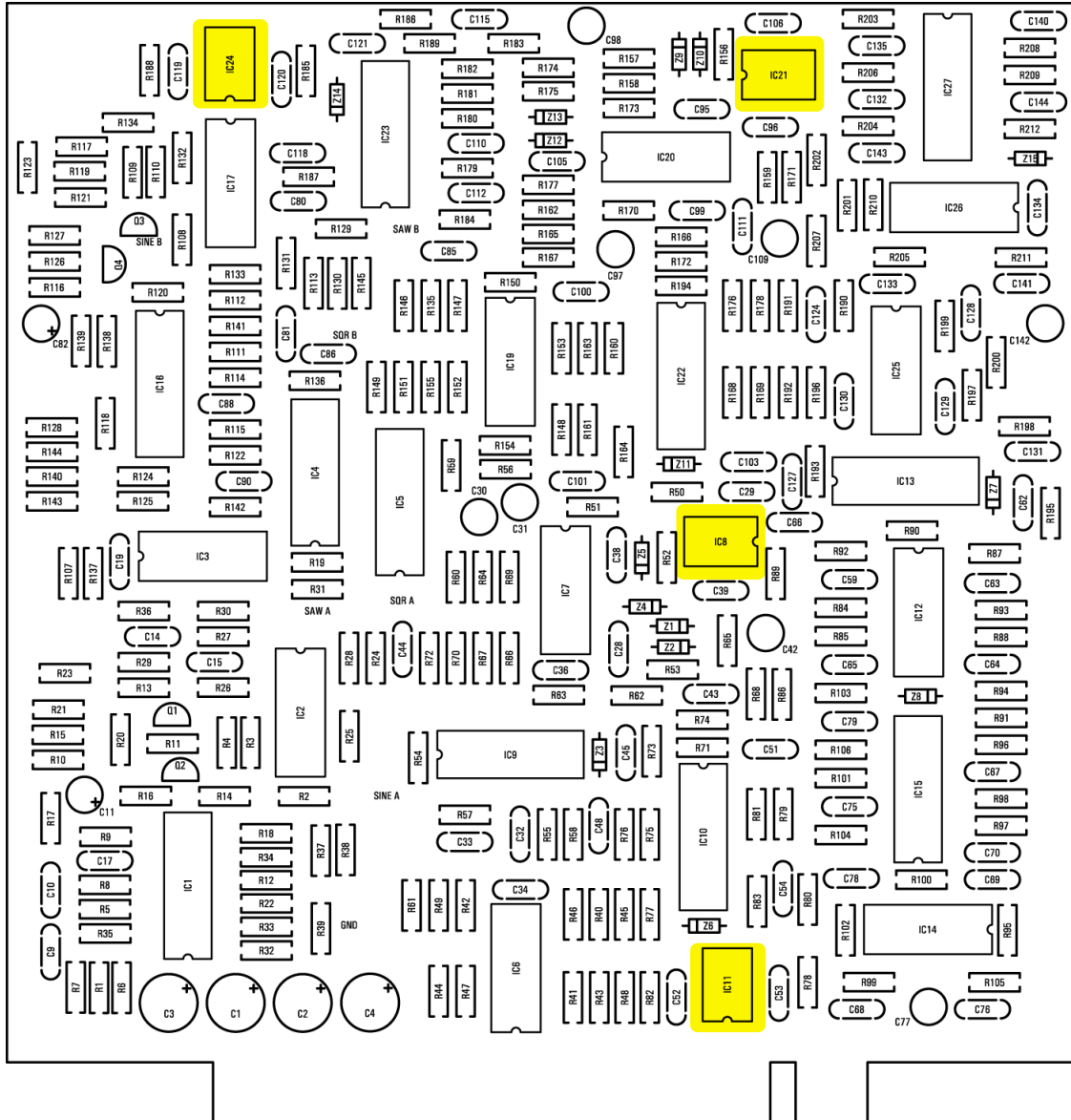

DECKARD'S DREAM

VOICECARD | IC

V2164

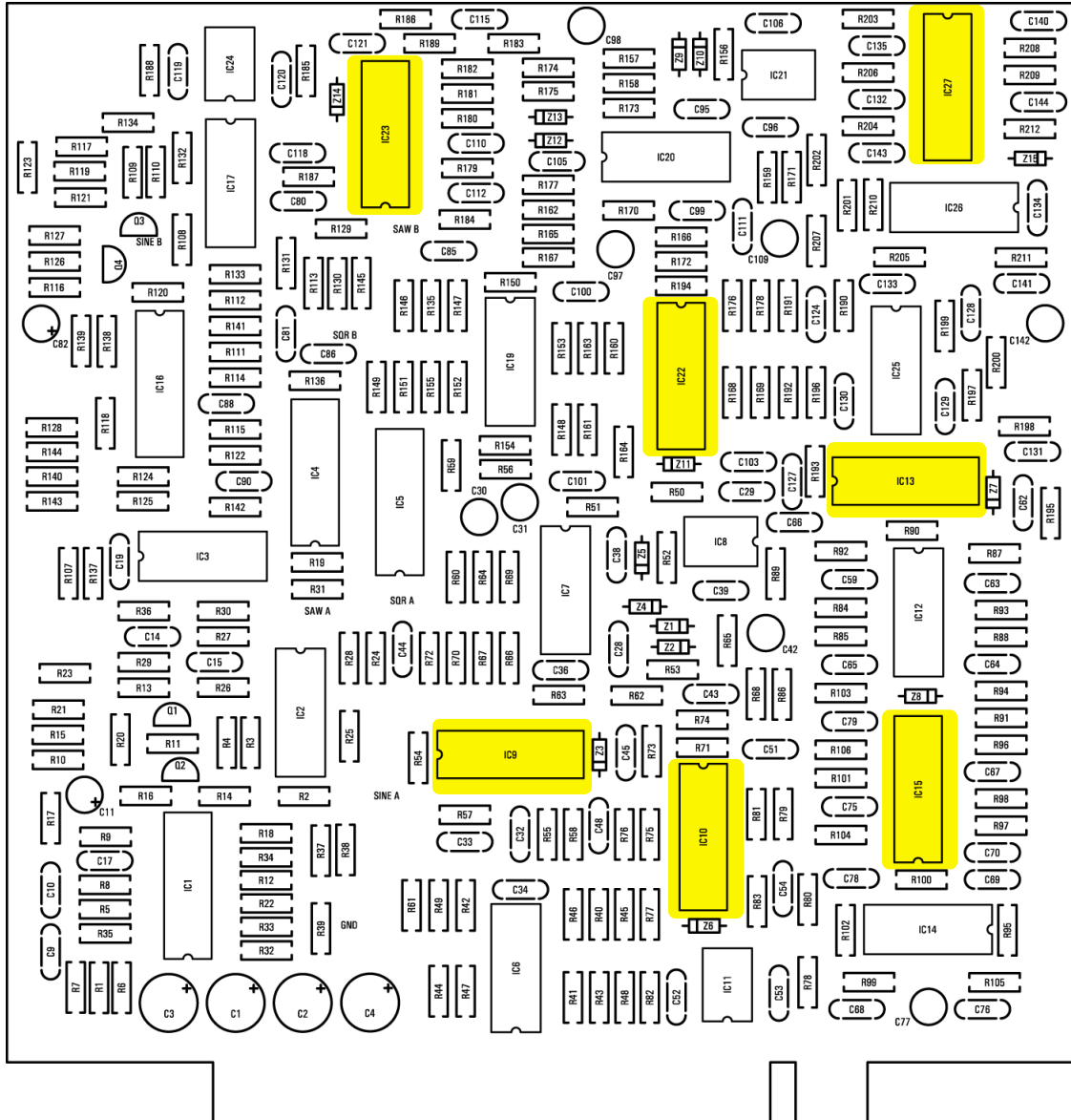

DECKARD'S DREAM

VOICECARD | IC

74LS74

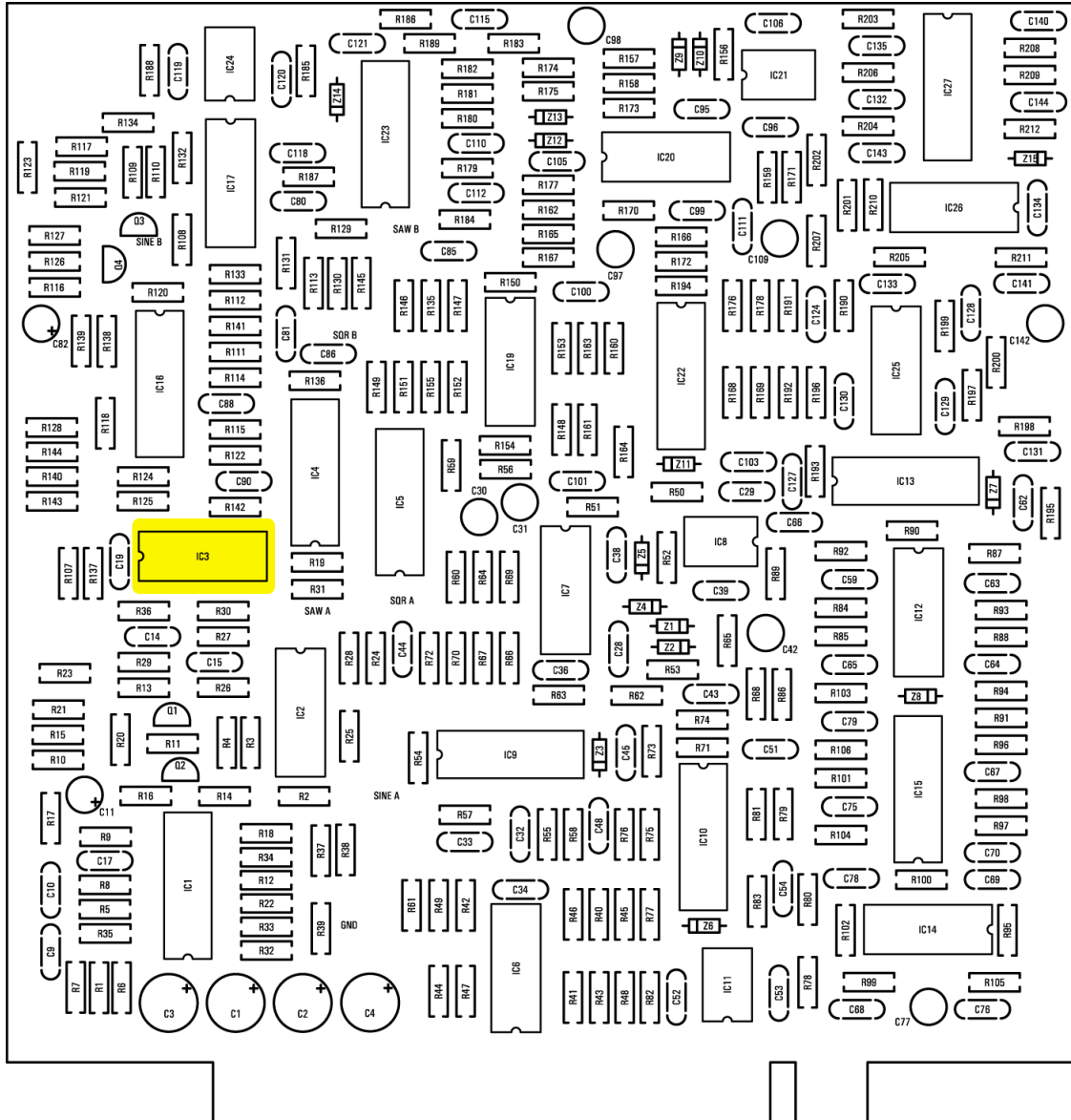

VOICECARD | IC

DG403

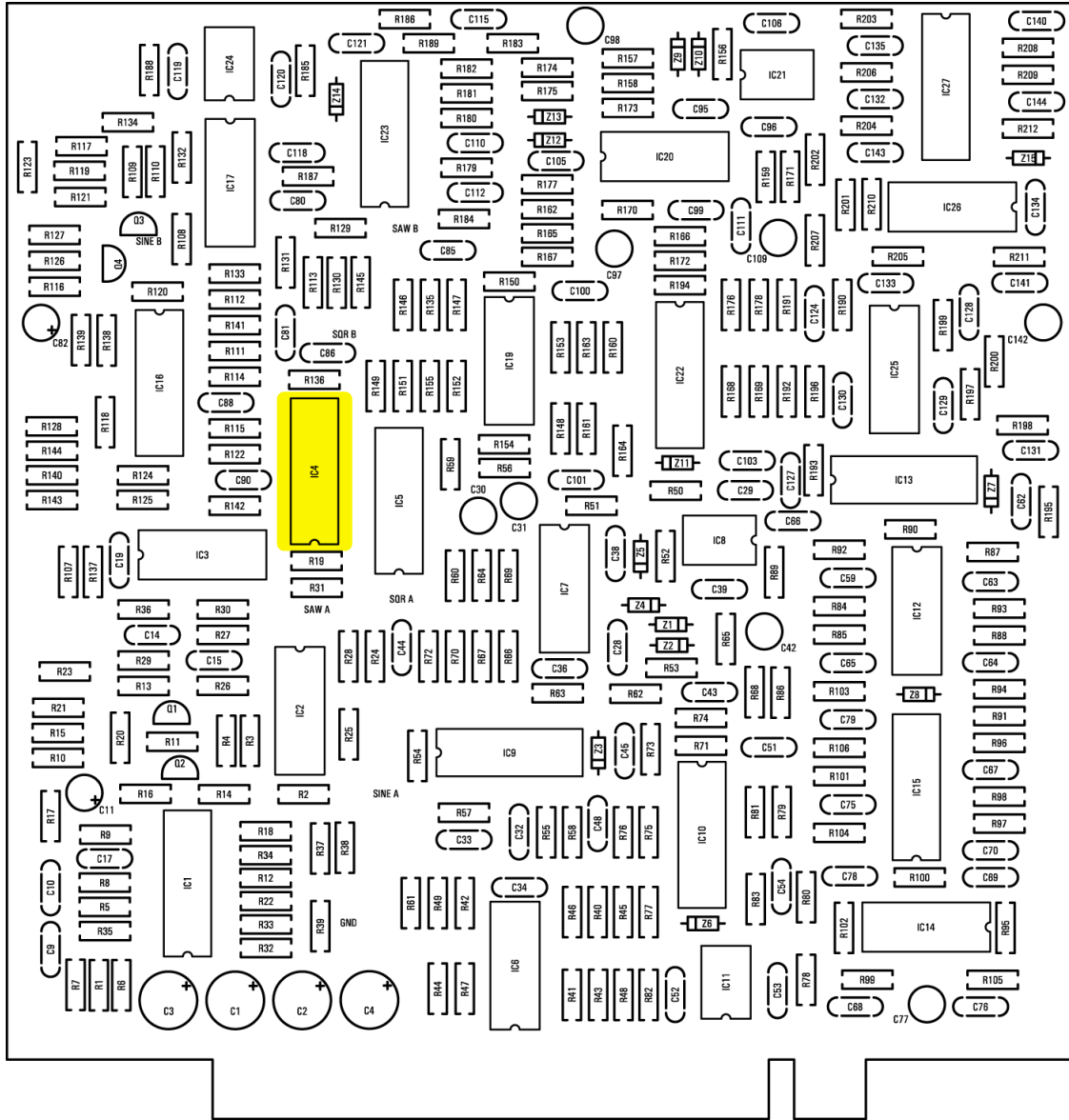

DECKARD'S DREAM

VOICECARD | IC

DG202

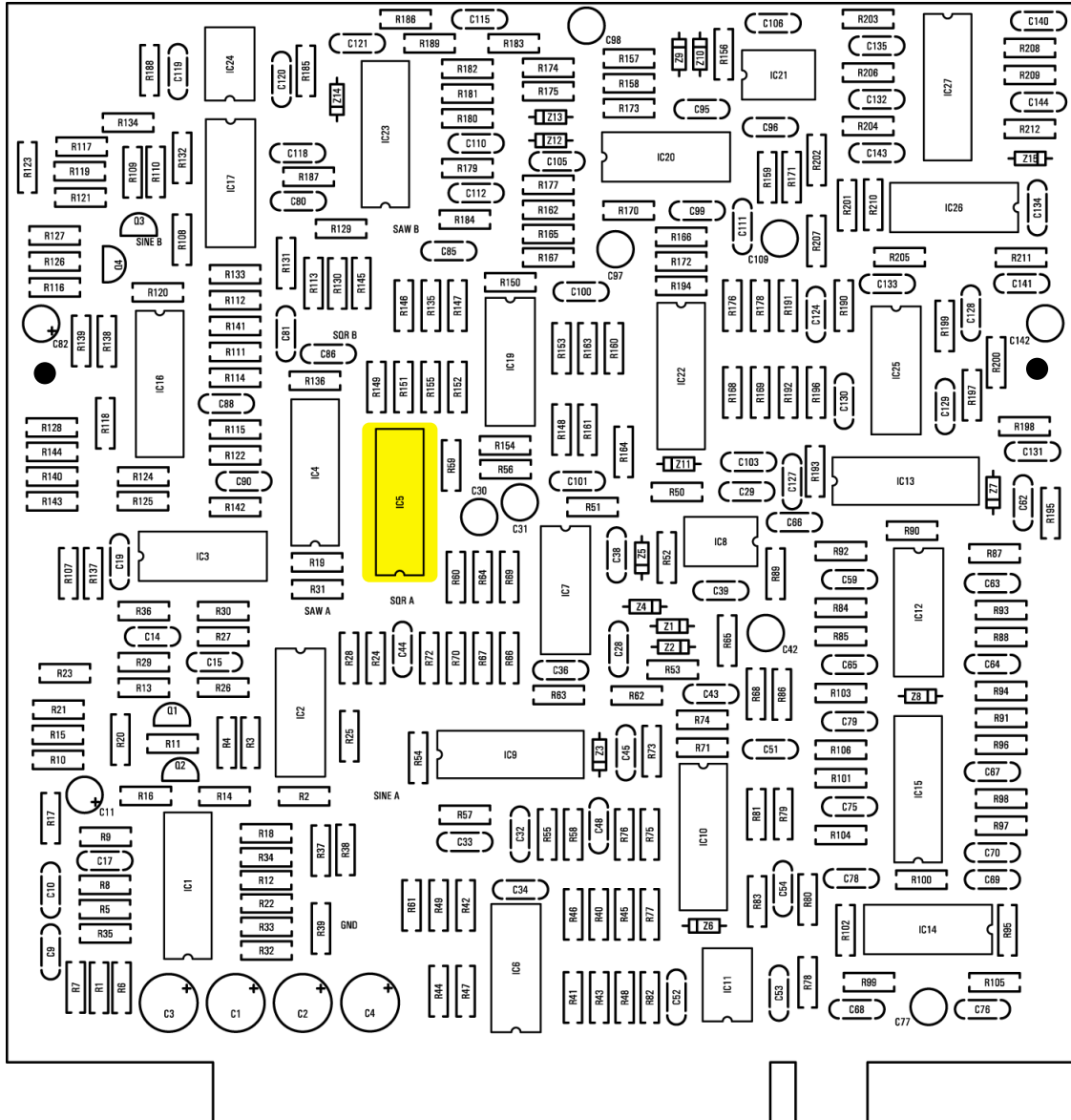

DECKARD'S DREAM